

Reading Wiring Diagrams

00R

GROUND POINTS

- This shows ground points of the harness.

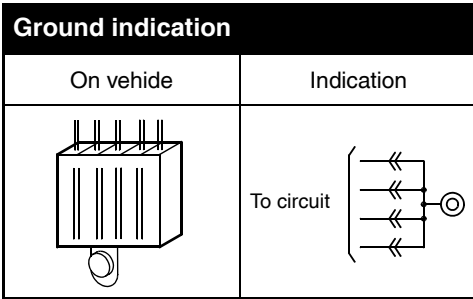
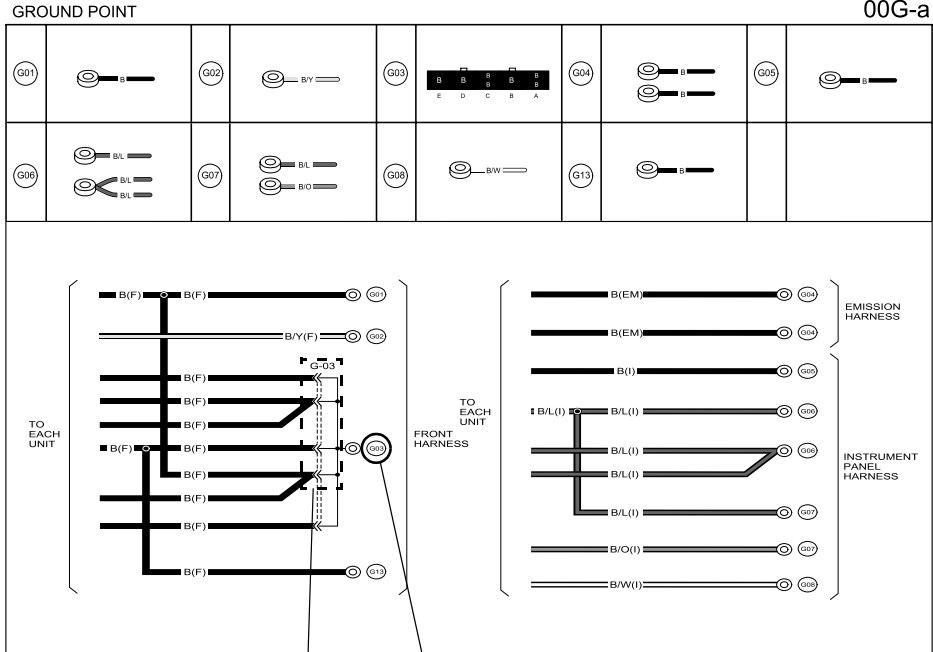

On circuit diagrams and ground points
 The ground connection numbers in system circuit diagrams correspond to those in the ground point diagram.

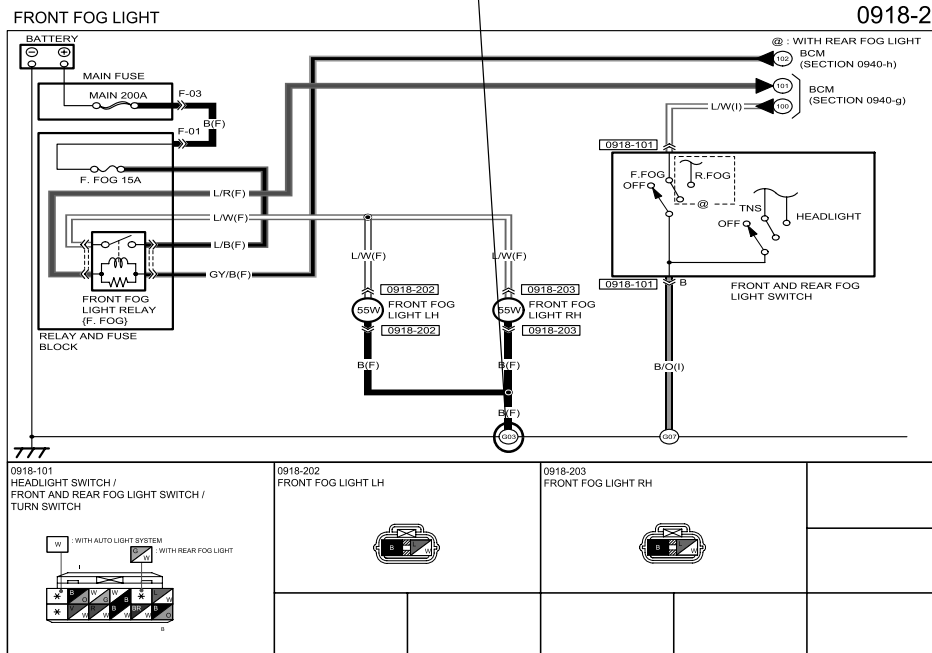

00R

Reading Wiring Diagrams

SYSTEM CIRCUIT DIAGRAM/CONNECTOR DIAGRAM

- These diagrams show the circuits for each system, from the power supply to the ground. The power supply side is on the upper part of the page, the ground side on the lower part. The diagrams describe circuits with the ignition switch off.
- Below is an explanation of the various points in the diagram.

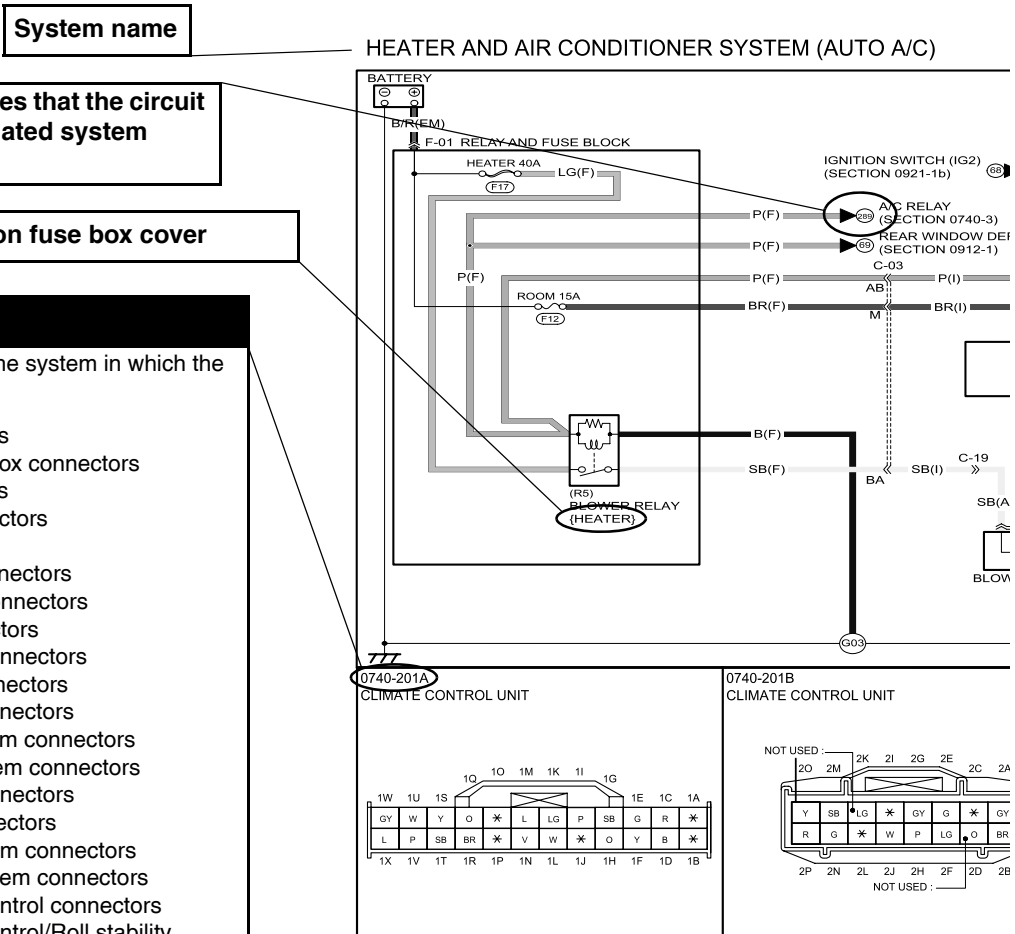

Indicates shielded wire.*

* Shielded wire :
 Prevents signal disturbances from electrical interference.
 Wire is covered by a metal meshing for grounding.

Current symbol

Current flows in the direction of the arrow.

Multiplex communication

Indicates communication with connected parts.
Signals are transmitted back and forth between connected parts.

System code

0740-2a

Wire color code (harness symbol)

- Two-color wires are indicated by a two-letter symbol. The first indicates the base color of the wire, the second the color of the stripe. For example:
W/R is a white wire with a red strip
BR/Y is a brown wire with a yellow strip

Symbol (Example)

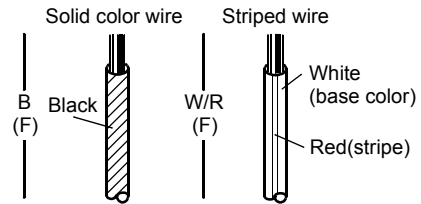

- The harness symbol is in () following the harness symbols (refer to P-9).

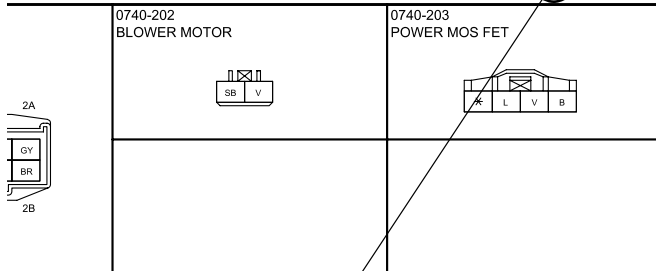
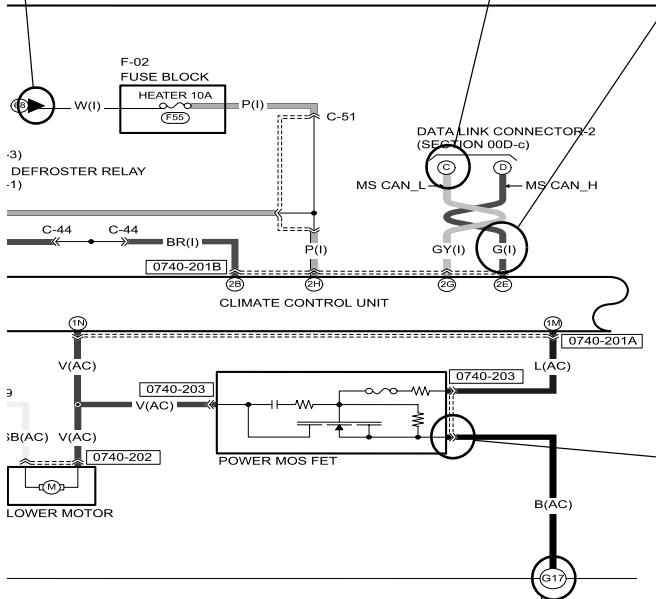

Connector symbols

- Male and female connectors are represented as follows in the circuit and connector diagrams.

		Circuit diagram symbol	Connector diagram symbol
Male			
Female			

- Like connectors are linked by dashed lines between the connector symbols.
- Connector diagrams show connectors on the harness side. The terminal indicates the view from the harness side.

(Example)

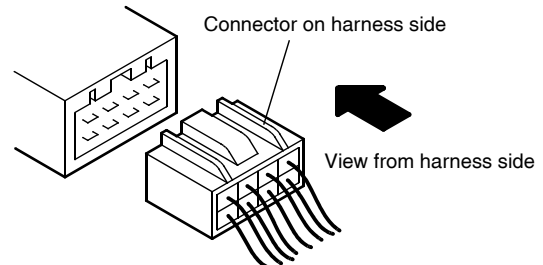

- Colors for connectors except white are given in locations.
- Unused terminals are indicated by *.

Ground numbers

A harness ground is represented differently than a unit ground.

Types of grounds	Symbol
Harness	
Unit	

00R

Reading Wiring Diagrams

ROUTING DIAGRAM

- The routing diagram shows where electrical components are on the system circuit diagram by call out line and connector symbols.

Connector symbol

Shows the system that uses the connector.

(Example)

Connector	Symbol
Common connectors	C-11
System connectors	0912-301

Ground symbol

Shows the ground in system diagrams.

Component name

Shows the names of components in routing diagrams.

REAR WINDOW DEFROSTER (INCLUDES HEATED OUTER MIRROR INFORMATION)

0912-1

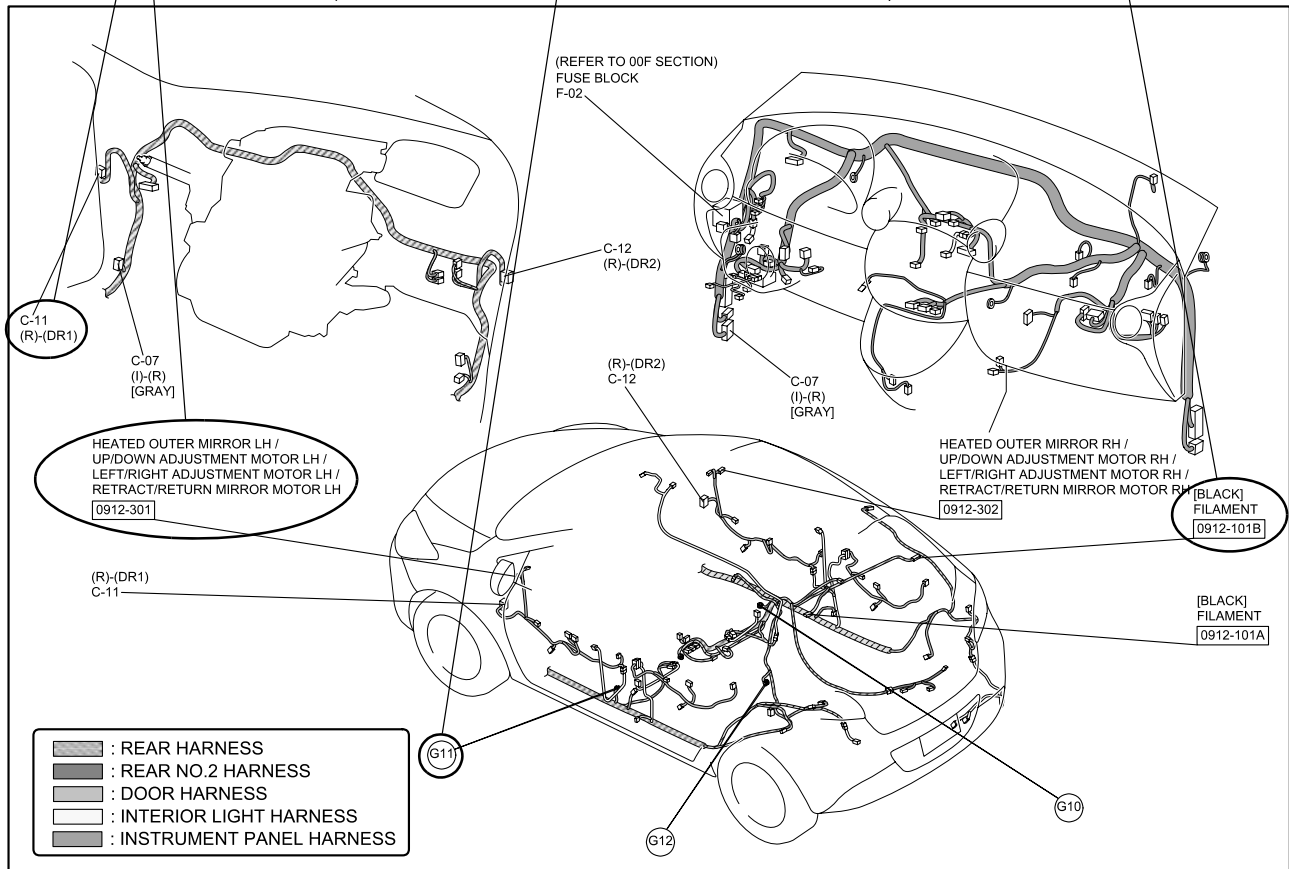

Reading Wiring Diagrams

00R







HARNESS SYMBOLS



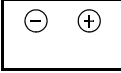

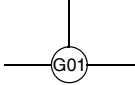

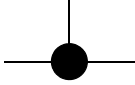
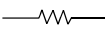
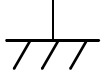

DESCRIPTION OF HARNESS	SYMBOL	DESCRIPTION OF HARNESS	SYMBOL
FRONT HARNESS	(F)	DOOR No. 1 HARNESS	(DR1)
FRONT No. 2 HARNESS	(F2)	DOOR No. 2 HARNESS	(DR2)
ENGINE HARNESS	(E)	DOOR No. 3 HARNESS	(DR3)
DASH HARNESS	(D)	DOOR No. 4 HARNESS	(DR4)
REAR HARNESS	(R)	FLOOR HARNESS	(FR)
REAR No. 2 HARNESS	(R2)	INTERIOR LIGHT HARNESS	(IN)
REAR No. 3 HARNESS	(R3)	A/C HARNESS	(AC)
INSTRUMENT PANEL HARNESS	(I)	INJECTION HARNESS	(INJ)
EMISSION HARNESS	(EM)	HAND BRAKE HARNESS	(HB)
EMISSION No. 2 HARNESS	(EM2)		
EMISSION No. 3 HARNESS	(EM3)		



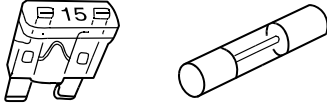
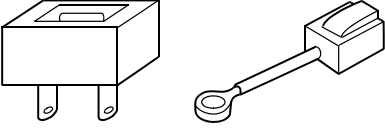

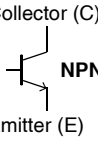
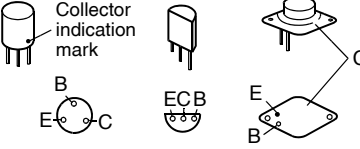

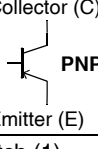

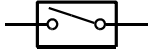
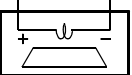
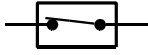
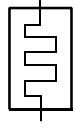
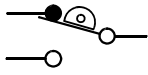
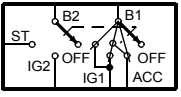
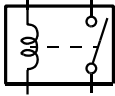
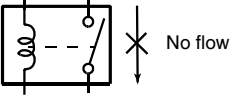
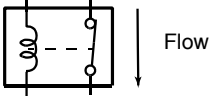
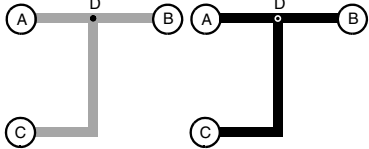
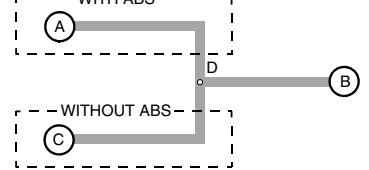

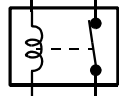
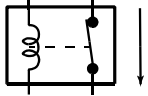
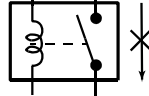





WIRING COLOR CODE

COLOR	CODE	COLOR	CODE
BLACK	B	ORANGE	O
BLUE	L	PINK	P
BROWN	BR	RED	R
DARK BLUE	DL	SKY BLUE	SB
DARK GREEN	DG	TAN	T
GRAY	GY	VIOLET	V
GREEN	G	WHITE	W
LIGHT BLUE	LB	YELLOW	Y
LIGHT GREEN	LG		

SYMBOLS

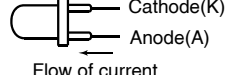
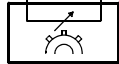
Symbol	Meaning	Symbol	Meaning
Battery 	<ul style="list-style-type: none"> Generates electricity through chemical reaction. Supplies direct current to circuits. 	Light 	<ul style="list-style-type: none"> Emits light and generates heat when current flows through filament.
Ground (1) 	<ul style="list-style-type: none"> Connecting point to vehicle body or other ground wire where current flows from positive to negative terminal of battery. Ground (1) indicates a ground point to body through wire harness. Ground (2) indicates point where component is grounded directly to body. Remarks <ul style="list-style-type: none"> Current will not flow through a circuit if ground is faulty. 		
Ground (2) 		Resistance 	<ul style="list-style-type: none"> A resistor with a constant value. Mainly used to protect electrical components in circuits by maintaining rated voltage.
Ground (3) 		Motor 	<ul style="list-style-type: none"> Converts electrical energy into mechanical energy.

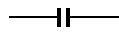
Symbol	Meaning	Symbol	Meaning
	<p>Fuse</p> <ul style="list-style-type: none"> Melts when current flow exceeds that specified for circuit, interrupts current flow. <p>Precautions</p> <ul style="list-style-type: none"> Do not replace with fuses exceeding specified capacity. 	<p>Pump</p> 	<ul style="list-style-type: none"> Pulls in and discharges gases and liquids.
<p>Fuse (For high current fuse)/ Fusible link</p> 	<p><Blade type> <Tube type></p>  <p><Cartridge type> <Fusible link></p> 	<p>Cigarette lighter</p> 	<ul style="list-style-type: none"> Electrical coil that generates heat.
<p>Transistor (1)</p> 	<ul style="list-style-type: none"> Electrical switching component. Turns on when voltage is applied to the base (B). 	<p>Accessory socket</p> 	<ul style="list-style-type: none"> Interior power supply.
<p>Transistor (2)</p> 	<ul style="list-style-type: none"> Reading code. <p>2 S C 828 A Revision mark</p> <p>Semiconductor A: High-frequency PNP Number of terminals B: Low-frequency PNP C: High-frequency NPN D: Low-frequency NPN</p>	<p>Horn</p> 	<ul style="list-style-type: none"> Generates sound when current flows.
<p>Switch (1)</p>  <p>Normally open</p>	<ul style="list-style-type: none"> Allows or breaks current flow by opening and closing circuits. 	<p>Speaker</p> 	<ul style="list-style-type: none"> Generates heat when current flows.
<p>Switch (2)</p>  <p>Normally closed</p>		<p>Heater</p> 	
<p>Autostop switch</p> 	<ul style="list-style-type: none"> Automatically shuts off circuit when certain conditions are met. 	<p>Ignition switch</p> 	<ul style="list-style-type: none"> Turning ignition key switches circuit to operate various component. <p>(NOTE) Ignition switch is called engine switch on diesel vehicles.</p>
<p>Relay (1)</p>  <p>Normally open</p>	<ul style="list-style-type: none"> Current flowing through coil produces electromagnetic force causing contact to open or close. <p>No current to coil</p>  <p>Current to coil</p> 	<p>Harness Connection</p>  <p>When circuit C-D is connected to circuit A-B, the connection D is indicated by a black dot.</p> <p>Selection</p>  <p>Diversion point D for the different circuits according to the vehicle's specification is indicated by a white dot.</p> <p>For vehicles with ABS, use the A-B circuit.</p> <p>For vehicles without ABS, use the C-B circuit.</p>	

Symbol	Meaning	Symbol	Meaning
Relay (2)  Normally closed	<ul style="list-style-type: none"> Current flowing through coil produces electromagnetic force causing contact to close. <div style="display: flex; justify-content: space-around;"> <div style="text-align: center;"> <p>No current to coil</p>  <p>Flow</p> </div> <div style="text-align: center;"> <p>Current to coil</p>  <p>No flow</p> </div> </div>		
Sensor (1) 	<ul style="list-style-type: none"> Detects characteristics such as intake manifold vacuum and airflow amount according to resistance variation. 	Solenoid 	<ul style="list-style-type: none"> Current flowing through coil generates electromagnetic force to operate plungers.
Sensor (2) 	<ul style="list-style-type: none"> Detects resistance variation according to operation of other parts. 	Diode 	<ul style="list-style-type: none"> Known as a semiconductor rectifier, the diode allows current flow in one direction only. <div style="display: flex; justify-content: space-around;"> <div style="text-align: center;"> <p>Cathode(K)  Anode(A)</p> <p>← Flow of electric current</p> </div> <div style="text-align: center;"> <p>K  A K  A K  A</p> </div> </div>
Sensor (3) 	<ul style="list-style-type: none"> A resistor whose resistance variation according to temperature variation. When temperature increases, resistance decreases. 	Light-emitting diode (LED) 	<ul style="list-style-type: none"> A diode that lights when current flows. Unlike ordinary bulbs, the diode does not generate heat when lit. <div style="display: flex; justify-content: space-around;"> <div style="text-align: center;"> <p>Cathode(K)  Anode(A)</p> </div> <div style="text-align: center;">  <p>Flow of current</p> </div> </div>
Sensor (4) 	<ul style="list-style-type: none"> Detects pulse signals from rotating object. 		
Sensor (5) 	<ul style="list-style-type: none"> Generates potential difference when tension or pressure is applied. 		
Capacitor 	<ul style="list-style-type: none"> Component that temporarily stores electrical charge. 	Reference diode (Zener diode) 	<ul style="list-style-type: none"> Allows current to flow in one direction up to a certain voltage; allows current to flow in the other direction once that voltage is exceeded.

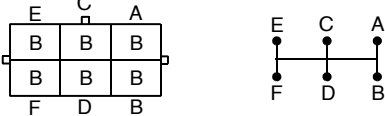
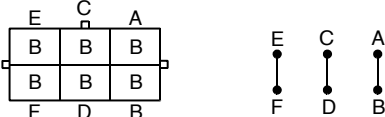
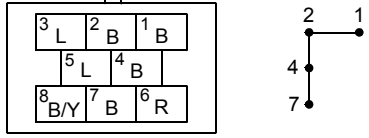
Symbol	Meaning
Extent of the change in the wiring position (1) 	<ul style="list-style-type: none"> The wiring position can be exchanged freely within the connector.
Extent of the change in the wiring position (2) 	<ul style="list-style-type: none"> The wiring position can be exchanged according to the following combinations only. Between A and B, Between C and D, Between E and F
Extent of the change in the wiring position (3) 	<ul style="list-style-type: none"> The wiring position can be exchanged according to the following combinations only. Between 1, 2, 4 and 7. The wiring positions may be indicated by numbers for some connectors.

00R

Reading Wiring Diagrams

SERVICE WARNING AND CAUTION FOR VEHICLES WITH SRS AIR BAG SYSTEM

If the SRS air bag system inspection is not performed correctly in accordance with the workshop manual procedures it could cause the system to operate (deploy) accidentally, resulting in injury.

Always follow the service warnings and cautions in the workshop manual when performing the SRS air bag system-related inspection or servicing.

SERVICE WARNING FOR VEHICLES WITH DISCHARGE HEADLIGHTS

If the discharge headlight inspection and servicing is not done using the correct procedures in the workshop manual, it could result in electrical shock.

Always follow the service warnings and cautions in the workshop manual when performing the discharge headlight-related inspection or servicing.

ABBREVIATIONS USED IN THIS MANUAL

3GR	THIRD GEAR
4GR	FOURTH GEAR
A	AMPERE
A/C	AIR CONDITIONING
A/F	AIR FUEL RATIO
AAS	AUTO ADJUSTING SUSPENSION
ABS	ANTILOCK BRAKE SYSTEM
ACC	ACCESSORIES
ACV	AIR CONTROL VALVE
ADD	ADDITIONAL
AIS	AIR INJECTION SYSTEM
ALL	AUTOMATIC LOAD LEVELING
AM	AMPLITUDE MODULATION
AMP	AMPLIFIER
ANT	ANTENNA
ASV	AIR SUPPLY VALVE
AT	AUTOMATIC TRANSMISSION
ATX	AUTOMATIC TRANSAXLE
B+	BATTERY POSITIVE VOLTAGE
BAC	BYPASS AIR CONTROL
BTN	BRAKE TAIL NUMBER
CAN	CONTROLLER AREA NETWORK
CIGAR	CIGARETTE
CIS	CONTINUOUS FUEL INJECTION SYSTEM
CKP	CRANKSHAFT POSITION SENSOR
CM	CONTROL MODULE
CMP	CAMSHAFT POSITION SENSOR
COMBI	COMBINATION
CON	CONDITIONER
CONT	CONTROL
CPU	CENTRAL PROCESSING UNIT
CV	CANISTER VENT
DEF	DEFROSTER
DI	DISTRIBUTOR IGNITION
DLC	DATA LINK CONNECTOR
DLI	DISTRIBUTORLESS IGNITION
DOHC	DOUBLE-OVERHEAD CAMSHAFT
DRL	DAYTIME RUNNING LIGHT

DSC	DYNAMIC STABILITY CONTROL
DTC	DIAGNOSTIC TROUBLE CODE(S)
DTM	DIAGNOSTIC TEST MODE
ECPS	ELECTRONICALLY CONTROLLED POWER STEERING
ECT	ENGINE CONTROL TEMPERATURE
EGR	EXHAUST GAS RECIRCULATION
EHPAS	ELECTRO HYDRAULIC POWER ASSIST STEERING
EI	ELECTRONIC IGNITION
ELEC	ELECTRIC
ELR	EMERGENCY LOCKING RETRACTOR
ET	ELECTRONIC THROTTLE
ETC	ELECTRONIC THROTTLE CONTROL
EPS	ELECTRIC POWER STEERING
EVAP	EVAPORATIVE EMISSION
F	FRONT
F/I	FUEL INJECTOR
FICB	FAST-IDLE CAM BREAKER
FM	FREQUENCY MODULATION
FP	FUEL PUMP
FPR	FUEL PUMP RELAY
GEN	GENERATOR
GND	GROUND
H/D	HEATER/DEFROSTER
HEAT	HEATER
HI	HIGH
HO2S	HEATED OXYGEN SENSOR
HS	HIGH SPEED
HU	HYDRAULIC UNIT
IAC	IDLE AIR CONTROL
IAT	INTAKE AIR TEMPERATURE
IG	IGNITION
ILLUMI	ILLUMINATION
INT	INTERMITTENT
JB	JOINT BOX
KS	KNOCK SENSOR
LCD	LIQUID CRYSTAL DISPLAY
LF	LEFT FRONT

Reading Wiring Diagrams

00R

LH	LEFT HAND
LO	LOW
LR	LEFT REAR
M	MOTOR
MAF	MASS AIR FLOW
MAP	MANIFOLD ABSOLUTE PRESSURE
MFI	MULTIPOINT FUEL INJECTION
MID	MIDDLE
MIL	Malfunction Indicator Lamp
MIN	MINUTE
MIX	MIXTURE
MPX	MULTIPLEX
MS	MIDDLE SPEED
MT	MANUAL TRANSMISSION
MTX	MANUAL TRANSAXLE
N	NEUTRAL
NC	NORMALLY CLOSED
NO	NORMALLY OPEN
O2S	OXYGEN SENSOR
OBD	ON-BOARD DIAGNOSTIC
O/D	OVER DRIVE
OFF	SWITCH OFF
ON	SWITCH ON
OSC	OSCILLATOR
P	POWER
P/S	POWER STEERING
PCM	POWERTRAIN CONTROL MODULE
PJB	PASSENGER JUNCTION BOX
PNP	PARK/NEUTRAL POSITION
PRC	PRESSURE REGULATOR CONTROL
PRG	PURGE SOLENOID VALVE
PSP	POWER STEERING PRESSURE
PTC	POSITIVE TEMPERATURE COEFFICIENT HEATER
PWM	PULSE WIDTH MODULATION
QSS	QUICK-START SYSTEM
R	REAR
REC	RECIRCULATION
RES	REAR ENTERTAINMENT SYSTEM
RF	RIGHT FRONT
RH	RIGHT HAND
RPM	REVOLUTIONS PER MINUTE
RR	RIGHT REAR
RSC	ROLL STABILITY CONTROL
SAS	SOPHISTICATED AIR BAG SENSOR
SFI	SEQUENTIAL MULTIPOINT FUEL INJECTION
SOL	SOLENOID

SPV	SPILL VALVE
ST	START
SW	SWITCH
TC	TURBOCHARGER
TCC	TORQUE CONVERTER CLUTCH
TCM	TRANSMISSION(TRANSAXLE) CONTROL MODULE
TCS	TRACTION CONTROL SYSTEM
TEMP	TEMPERATURE
TFT	TRANSAXLE FLUID TEMPERATURE
TICS	TRIPLE INDUCTION CONTROL SYSTEM
TNS	TAIL NUMBER SIDE LIGHTS
TP	THROTTLE POSITION SENSOR
TR	TRANSMISSION(TRANSAXLE) RANGE
TWS	TOTAL WIRING SYSTEM
V	VOLT
VAF	VOLUME AIR FLOW SENSOR
VENT	VENTILATION
VICS	VARIABLE INERTIA CHARGING SYSTEM
VOL	VOLUME
VR	VOLTAGE REGULATOR
VRIS	VARIABLE RESONANCE INDUCTION SYSTEM
VSS	VEHICLE SPEED SENSOR
VTCS	VARIABLE TUMBLE CONTROL SYSTEM
W	WATT(S)
WOT	WIDE OPEN THROTTLE

00P Electrical System General Procedures

ELECTRICAL PARTS

B6U00000006W03

Battery Cable

- Before disconnecting connectors or removing electrical parts, disconnect the negative battery cable.

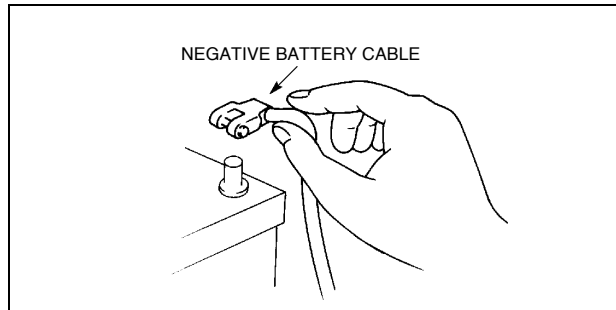

WGIWXX0007E

Wiring Harness

- To remove the wiring harness from the clip in the engine room, pry up the hook of the clip using a flathead screwdriver.

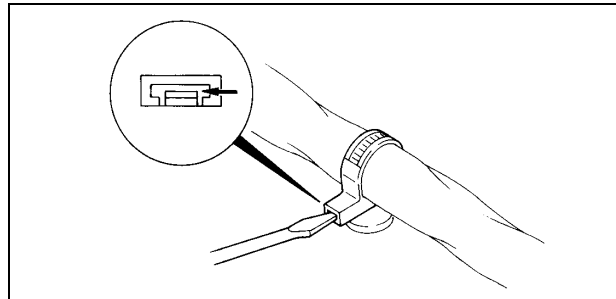

WGIWXX00039E

Caution

- Do not remove the Harness protective tape. Otherwise, the wires could rub against the body, which could result in water penetration and electrical shorting.

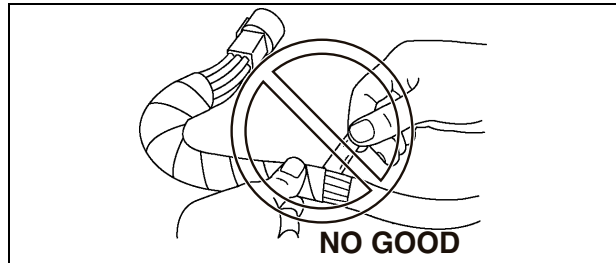

WGIWXX00040E

CONNECTORS

Disconnecting Connectors

- When disconnecting connector, grasp the connectors, not the wires.

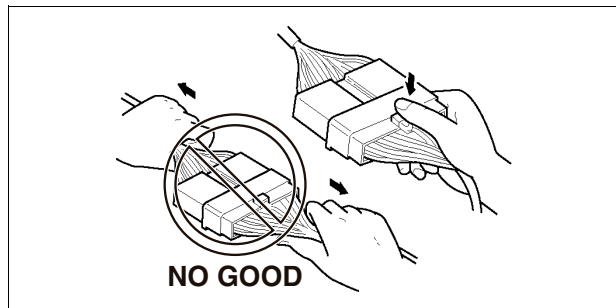

WGIWXX00041E

Electrical System General Procedures 00P

- Connectors can be disconnected by pressing or pulling the lock lever as shown.

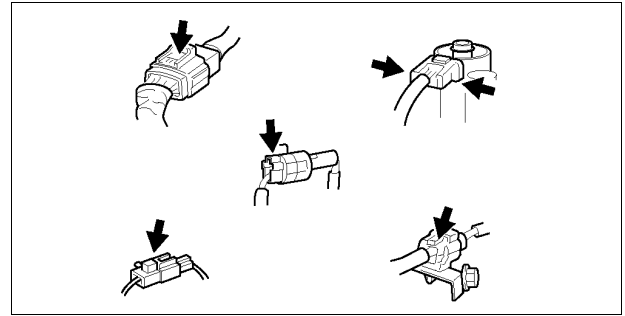

WGIWXX0042E

Locking Connector

- When locking connectors, listen for a click indicating they are securely locked.

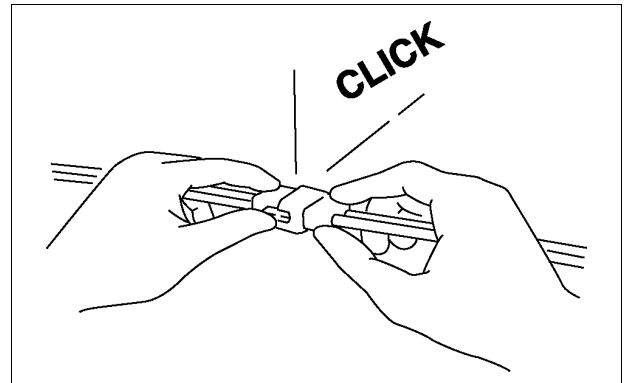

X3U000WB1

Inspection

- When a tester is used to inspect for continuity or measuring voltage, insert the tester probe from the wiring harness side.

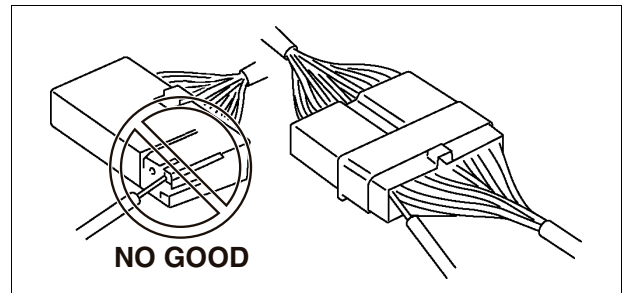

WGIWXX0044E

- Inspect the terminals of waterproof connectors from the connector side since they cannot be accessed from the wiring harness side.

Caution

- To prevent damage to the terminal, wrap a thin wire around the tester probe before inserting into terminal.

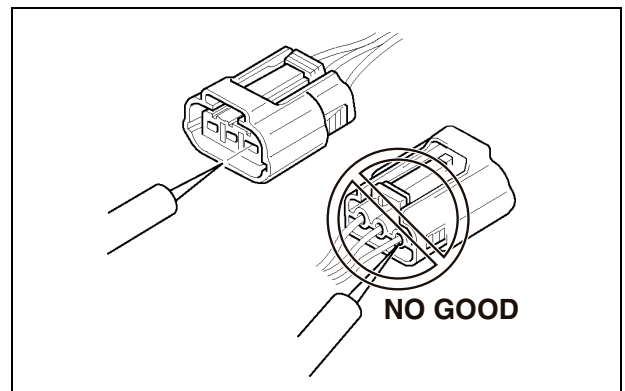

WGIWXX0045E

00P Electrical System General Procedures

Terminals

Inspection

- Pull lightly on individual wires to verify that they are secured in the terminal.

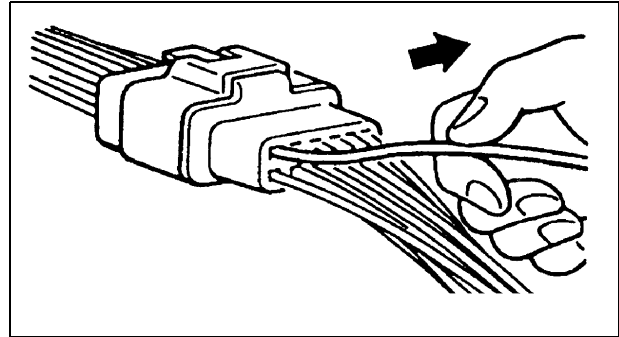

X3U000WB4

Replacement

- Use the appropriate tools to remove a terminal as shown. When installing a terminal, be sure to insert it until it locks securely.
- Insert a thin piece of metal from the terminal side of the connector and with the terminal locking tab pressed down, pull the terminal out from the connector.

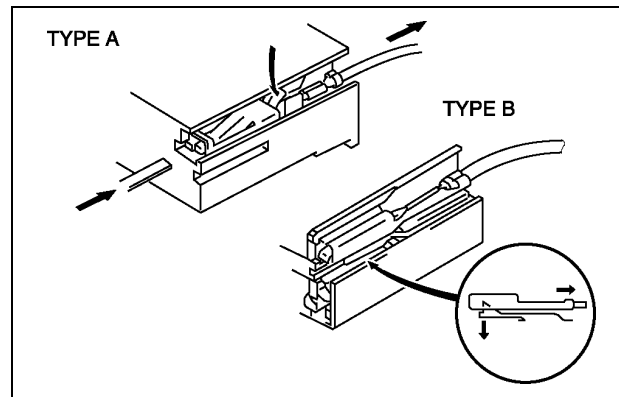

X3U000WB5

Sensors, Switches, And Relays

- Handle sensors, switches, and relays carefully. Do not drop them or strike them against other objects.

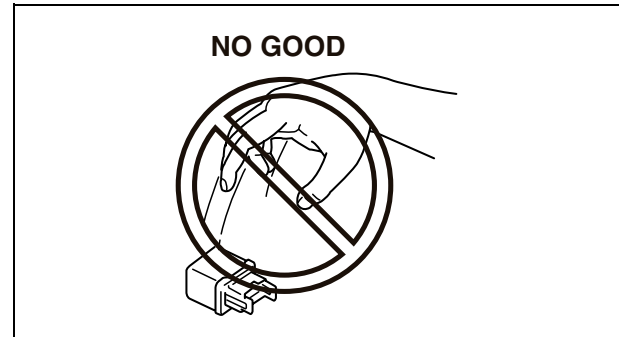

X3U000WB6

Fuse

Replacement

- When replacing a fuse, be sure to replace it with one of the same capacity. If a fuse fails again, the circuit probably has a short and the wiring should be inspected.
- Be sure the negative battery terminal is disconnected before replacing a main fuse.

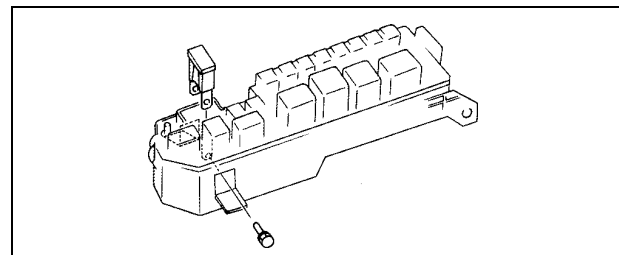

YMU000WA1

Electrical System General Procedures 00P

- When replacing a pullout fuse, use the fuse puller.

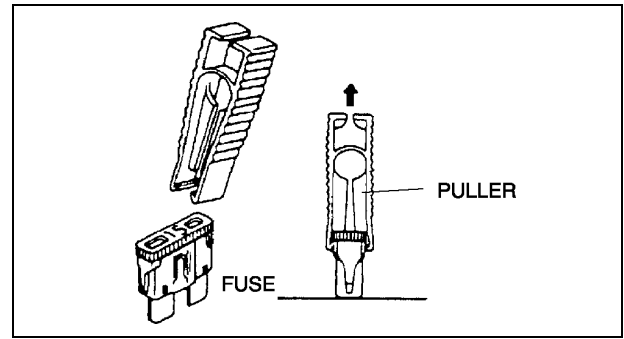

YMU000WAK

ELECTRICAL TROUBLESHOOTING TOOLS

Jumper Wire

- A jumper wire is used to create a temporary circuit. Connect the jumper wire between the terminals of a circuit to bypass a switch.

Caution

- Do not connect a jumper wire from the power source line to a body ground. This may cause burning or other damage to wiring harnesses or electronic components.

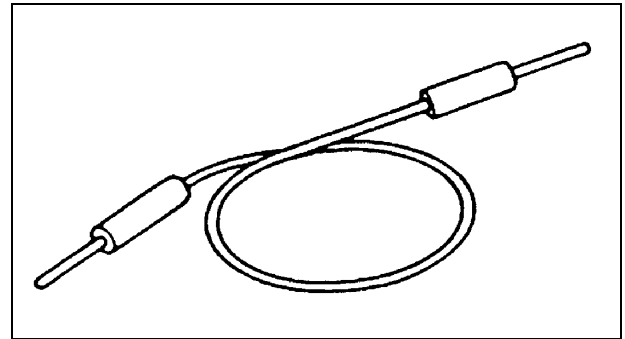

X3U000WBB

Voltmeter

- The DC voltmeter is used to measure circuit voltage. A voltmeter with a range of **15 V or more** is used by connecting the positive (+) probe (red lead wire) to the point where voltage will be measured and the negative (-) probe (black lead wire) to a body ground.

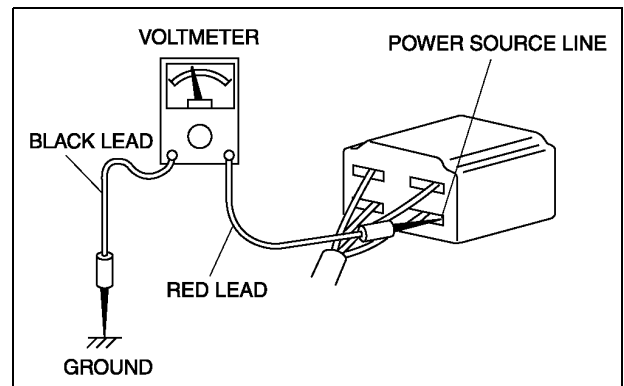

X3U000WBC

Ohmmeter

- The ohmmeter is used to measure the resistance between two points in a circuit and to inspect for continuity and short circuits.

Caution

- Do not connect the ohmmeter to any circuit where voltage is applied. This will damage the ohmmeter.

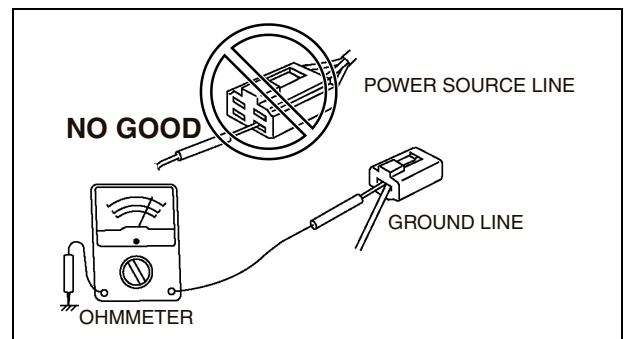

YMU000WAL