

GENUINE

REAR SPOILER



Using (Installation) Instructions

Thank you very much for buying the **Rear Spoiler**.

To use it in its best conditions, you are expected to carefully read these using (installation) instructions for full understanding of the contents and to properly use it.

Please keep these instructions so that you can consult them every time you use the deflector.

Cautions and Requests

-  CAUTION and  WARNING marks shown in these instructions indicate safety precautions, which you are requested to strictly comply with during installation and use.
- Do not ever alter the product when installing it.
- Always avoid any installation and use that are not stated in these instructions.
- To avoid any improper installation, it is recommended to have the product installed at an exclusive Mazda dealer.
- Contact the dealer of your purchase for any further information you wish to know on the installation and use of the product and ensure you are in full understanding of the product before starting the installation or use.
- We may not accept the liability for any problems that might have occurred due to non-compliance with these instructions.

1

PART NUMBER

F151 V4 920F

APPLICABLE MODEL

RX-8

※ Contact the dealer for applicable models or any other information.

Request

Please ensure that these using (installation) instructions be delivered to the customer.

F151 PK 926 2003-04

Mazda Motor Corporation

3-1, Shinchi, Fuchu-cho, Aki-gun Hiroshima

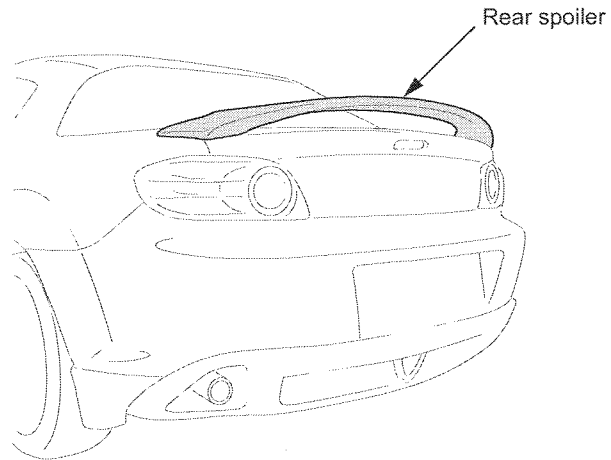
2**AS-COMPLETED VIEW****3****COMPONENTS****CAUTION**

Make sure that there is no missing component based on the following parts list and check the components for any dirt, scratches or other damage.

No.	Part name	Q'ty	Part number
①	Rear spoiler	1	_____
②	Set screw	4	9YA02 0612
③	Using (installation) instructions	1	_____
④	Template	1	_____
⑤	Stay damper	2	FE15 56 930

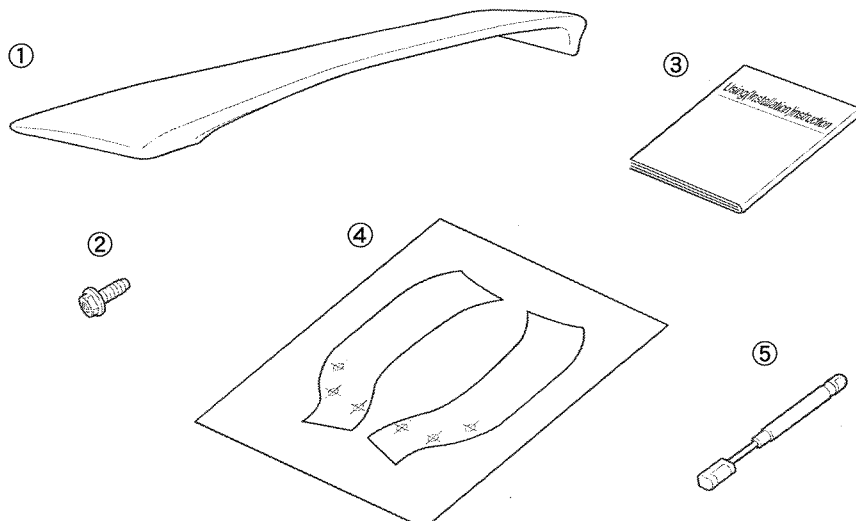

4

PREPARATORY WORK BEFORE INSTALLATION

Tools used (Have them ready at hand before starting the work.)

- ◆ Phillips-type screwdriver
- ◆ File
- ◆ Electric drill ($\phi 3\text{mm}$, $\phi 5\text{mm}$, $\phi 8\text{mm}$, $\phi 10\text{mm}$)
- ◆ Socket wrench and spanner (8mm, 10mm), torque wrench (T20)
- ◆ Punch etc.
- ◆ Touch-up paint (genuine part)
- ◆ Soft cloth (clean one)
- ◆ IPA (isopropyl alcohol) and white gasoline
- ◆ Paper double-faced adhesive tape etc., gum tape etc., and protective tape
- ◆ Protective sheet
- ◆ Scissors, air gun

CAUTION

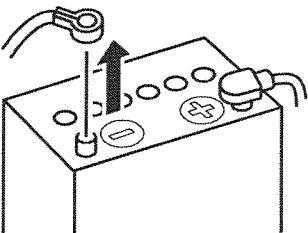
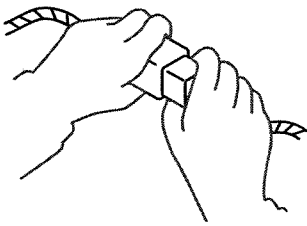
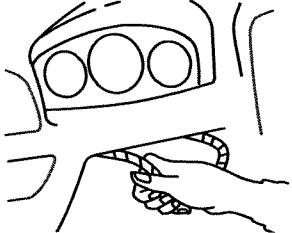
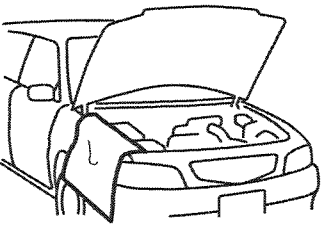
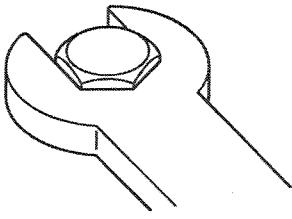
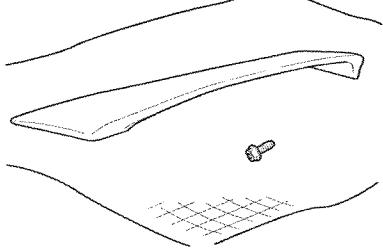
<p>Disconnect the negative terminal of the battery before doing the work.</p>	<p>Hold the connectors when disconnecting/connecting them to ensure the disconnection/connection.</p>	<p>Avoid exercising excessive force when pulling a wiring harness.</p>
		
<p>Use a mat or any other protective material when removing/installing components.</p>	<p>Use right tools appropriate for the purpose and size of the work to be done to ensure proper execution of the work.</p>	<p>Place the removed parts and components on a protective sheet or equivalent to avoid any damage on such parts/components.</p>
		

Note

- Consult the service manuals for the vehicle for the instructions on the removal and installation of the vehicle components.

CAUTION

- When the negative terminal of the battery gets disconnected, the memory of clock, radio and trip counter will be erased. Record the memory contents before starting the work.

WARNING

- Be sure to disconnect the negative battery cable before performing removal or installation procedure. Otherwise, serious injury or damage to the vehicle may occur.
- Always apply the parking brake before performing operations.

5

INSTALLING THE REAR SPOILER

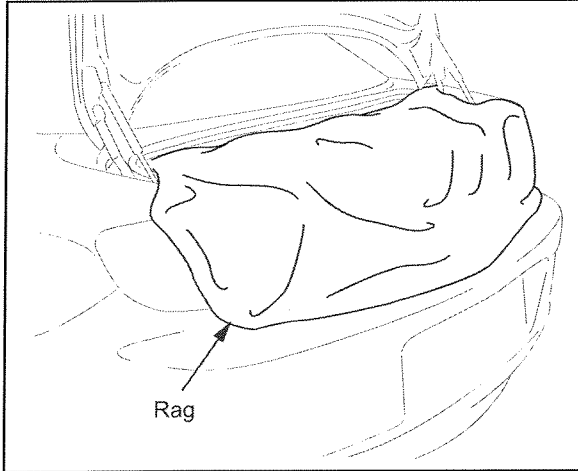

Protecting the vehicle

1. Prior to perforating the trunk lid, always cover with a rag the entire surface around the opening to protect the vehicle.

④ Template

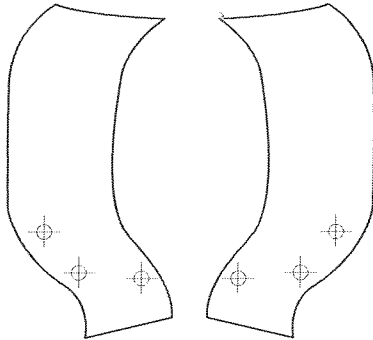

Boring the rear spoiler retaining holes

NOTE

- The boring procedure shown here is for the right-hand side only. Use the same procedure for the left-hand side parts.

1. Cut off the templates ④ as with scissors (one for each of the left and right)

2. Stick with adhesive tape the cut-off template ④ along the edge of the trunk (B) so the roundness of the edge of the trunk lid matches that of the template.
3. Punch the centers of the rear spoiler retaining points on the template ④ ("+" marked) for marking (at three points for each of the left and the right).

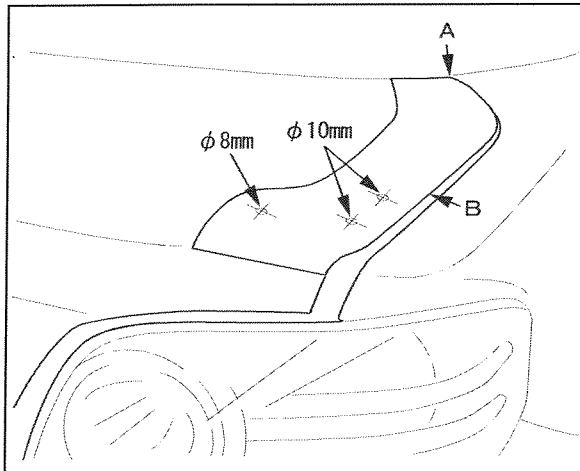

CAUTION

- Do not hit too hard when punching. Otherwise, the trunk lid may get deformed.

4. Peel off the template ④ from the trunk lid.

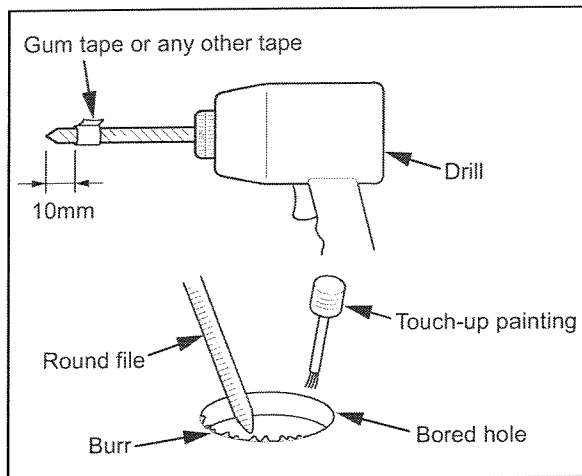

5. Perforating round holes

[Perforating round holes] · · · $\phi 8$ mm (one for each of the left and right)
 $\phi 10$ mm (two for each of the left and right)

Boring $\phi 8$ mm hole: Use $\phi 3$ mm, $\phi 5$ mm and $\phi 8$ mm drills successively to bore a hole.

Boring $\phi 10$ mm hole: Use $\phi 3$ mm, $\phi 5$ mm, $\phi 8$ mm and $\phi 10$ mm drills successively to bore a hole.

WARNING

- Exercise sufficient care in handling drills and other cutting tools to avoid any personal injuries.
- To prevent any damage on the bumper and drilling through beyond the limit, always wrap the drill blade as with gum tape.

6. Remove burrs on the back surface of the lid as with file.

7. Remove chips as with air gun.

CAUTION

- Any chips from the boring left in the trunk compartment or in the passenger compartment may cause corrosion or noises. Be sure to remove them.

8. Wipe as with isopropyl alcohol the vehicle body surface on which the rear spoiler is to be mounted to remove any grease and dirt.

9. To prevent corrosion, apply and dry touch-up paint.

10. Remove the rag or any their protection from the vehicle body.

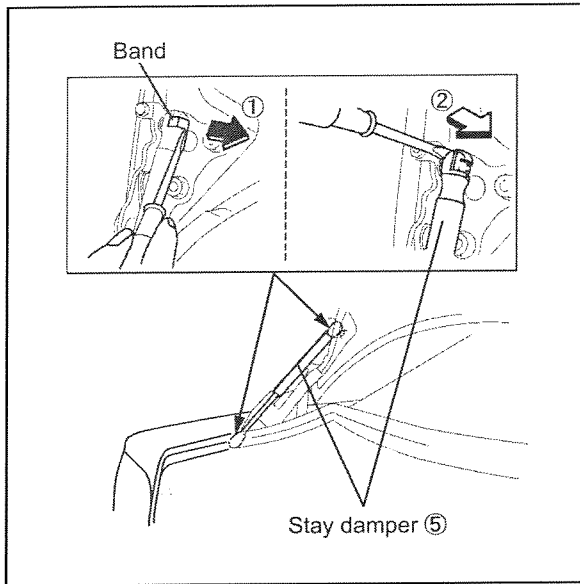

Stay damper removal / installation

⚠ WARNING

- Removing stay damper without supporting the trunk lid can be dangerous, as the trunk lid / lift gate may fall and injure you. Open the trunk lid / lift gate fully and support it before removing the stay damper ⑤. Always perform these procedures together with at least another person.

1. Using a flathead screwdriver, remove the bands (2 each side). Of the stay damper ⑤
2. Remove the stay damper ⑤ from the body and trunk lid / lift gate.
3. Install stay dampers ⑤.

NOTE

- Remove and install the stay damper on one side each.
- Though the figures are for the LH side. For RH side, perform the same procedure as on the LH side.
- The removed stay dampers ⑤ are not used for this accessory.

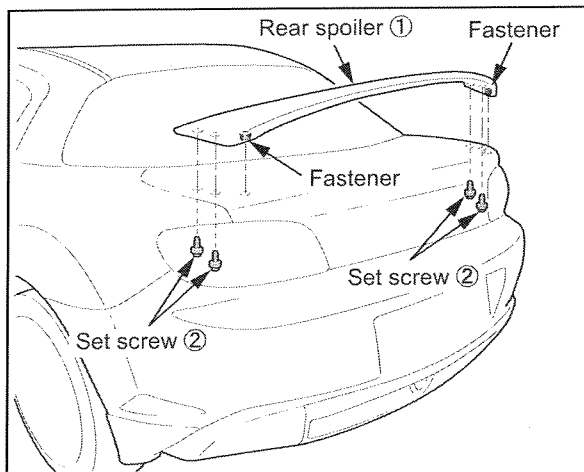

Installing the rear spoiler

1. Insert fasteners rear spoiler ① of the into the retaining holes ($\phi 8\text{mm}$) on the trunk lid.
2. Retain the rear spoiler ① on the trunk lid using set screws ② (two for each of the left and right).
Tightening torque: 6.8-9.8 Nm

⚠ CAUTION

- When installing the rear spoiler, make sure it is evenly positioned in both right-left and fore-aft directions.
- Make sure that the tightening has been properly completed.
- Tightening with any torque other than specified may cause damage on the rear spoiler or may cause it to come off. Always ensure a proper tightening.

AFTER INSTALLATION INSPECTION**WARNING**

- A falling trunk lid is dangerous. The trunk lid could fall on the head or neck and cause injury, and fingers could be pinched where the rear spoiler comes down on the rear fenders. Always stand back and test the trunk lid to make sure that it does not fall heavily.

**CAUTION**

- After driving, verify that the bolts are not loosened. Retighten them if necessary and check periodically. Otherwise, parts may loosen and fall during driving, causing an accident.

**CAUTION**

- Visually show the customer who will use the car where the spoiler comes down on the rear fenders so they do not pinch their fingers.

- (1) Stand back and test the trunk lid to verify that the lid does not fall hard, and that it is counterbalanced properly.
- (2) If the trunk lid falls too easily, first be sure to safely prop the lid up in place, then re-examine the balance spring installation instructions, and if the situation has not been resolved get assistance. If you can't resolve it at home, close the trunk carefully, and take it to a Mazda qualified mechanic to adjust.

Installation Inspection Sheet

[To be used by installation workshop]

RX-8	REAR SPOILER
	F151 V4 920F

Inspection items after completion of the work

- Inspect the installed parts and removed-and-reinstalled parts with respect to the following items.

Section to be inspected	Inspection item (circle)			
	Gap / fit & finish	Scratch, stain, tape residue	Tightening & engagement	Anti-corrosion treatment
Rear spoiler (kit components)	<input type="radio"/>	<input type="radio"/>	<input type="radio"/>	
Trunk lid		<input type="radio"/>		<input type="radio"/>

Rear spoiler installation inspection

Date		(year/month/day):			
VIN: No.					
Approved		Checked		Prepared	

※ Retention period of the sheet: 3 months