

A. VEHICLE INSPECTION PROCEDURE

NOTE:

- This recall consists of 4 possible repair procedures:
 - PROCEDURE “A” - CATALYTIC CONVERTER INSPECTION
 - PROCEDURE “B” - ENGINE DIFFICULT TO START
 - PROCEDURE “C” - DRIVABILITY CONCERNS
 - PROCEDURE “D” - PCM REPROGRAMMING

Follow the VEHICLE INSPECTION PROCEDURE carefully to determine which of the 4 repair procedures to perform on customer vehicles for this recall.

1. Verify that the vehicle is within the following ranges:
 - 2004 RX-8 VIN range (JM1 FE17** 40 100053 - 140891)
 - 2005 RX-8 VIN range (JM1 FE17** 50 140892 - 161178)
 - 2006 RX-8 VIN range (JM1 FE17** 60 200012 - 206995) - Due to delayed production, no US spec vehicles were built between VINs 161179-200011.
 - If the vehicle is within one of the above ranges, proceed to step 2.
 - If the vehicle is not within one of the above ranges, return the vehicle to the customer or inventory.
2. Perform a Warranty Vehicle Inquiry using your eMDCS System and inspect vehicle for a Campaign Label **RECALL 4206F** attached to the vehicle’s hood or bulkhead. Refer to eMDCS System - Warranty Vehicle Inquiry Results table below.

NOTE:

- Verify recall number as the vehicle may have multiple recalls.

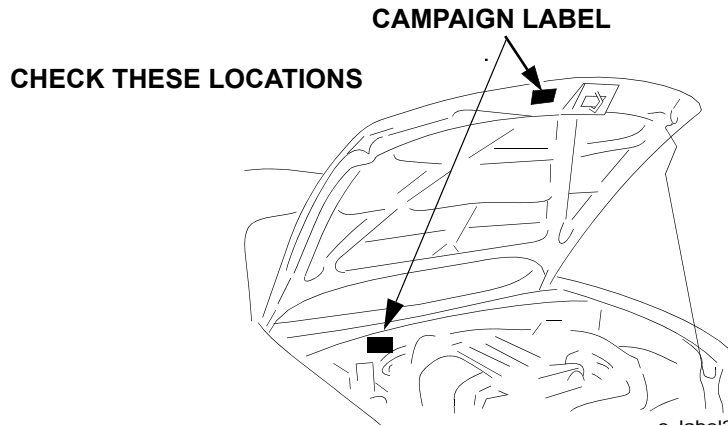

CAMPAIGN LABEL

CAMPAIGN NO: _____ DEALER CODE: _____ DATE: // //
P/N 9999-95-065A-05

1326b

eMDCS System - Warranty Vehicle Inquiry Results

If eMDCS displays:	Campaign Label is:	Action to perform:
RECALL 4206F OPEN	Present	Contact the Mazda Corporate Dealer Assistance Group at (877) 727-6626 to update vehicle history.
	Not present	Proceed to STEP 3.
RECALL 4206F CLOSED	Present	Return vehicle to inventory or customer.
	Not present	Complete a label and apply to vehicle's hood or bulk-head.
Recall 4206F is not displayed	Does not apply	Recall does not apply to this vehicle. Return vehicle to inventory or customer.

3. Check vehicle's warranty history for prior engine replacement and / or severe engine lack of power & low idle complaints. Record any warranty history for this concern on repair order.
4. Check vehicle's warranty history for spark plug replacement and/or if FQI was performed, within the past 12 months. Note if plugs have been replaced or not on repair order.
5. Ask customer if they are currently experiencing a severe lack of power and low idle complaints, and / or have previously experienced a severe lack of power and low idle concern.

NO - Perform the following procedures in this order:

- PROCEDURE "A" - CATALYTIC CONVERTER INSPECTION
- PROCEDURE "B" - ENGINE DIFFICULT TO START
- PROCEDURE "D" - PCM REPROGRAMMING

NOTE: It is not necessary to perform PROCEDURE "C" - DRIVABILITY CONCERNS if the customer has not experienced a severe lack of power / low idle concern and / or the engine has not been replaced.

YES - Perform the following repair procedures in this order:

- PROCEDURE "A" - CATALYTIC CONVERTER INSPECTION
- PROCEDURE "B" - ENGINE DIFFICULT TO START
- PROCEDURE "C" - DRIVABILITY CONCERNS
- PROCEDURE "D" - PCM REPROGRAMMING

B. REPAIR PROCEDURES

DRIVABILITY CONCERNS

Some vehicles may experience drivability concerns when driven in high ambient temperatures / low humidity conditions. This may be caused by improper PCM software calibration which controls the metering oil injection amount, which may result in poor sealing of the engine's combustion chambers. A revised PCM calibration which corrects the metering oil injection amount is part of PROCEDURE "D" PCM REPROGRAMMING.

NOTE:

- Some customers may experience an increase of engine oil consumption after the PCM has been reprogrammed. When releasing the vehicle to the customer, make sure to tell them they may experience an increase in oil consumption, and to check their engine oil level every other re-fueling.

ENGINE DIFFICULT TO START

Some vehicles may experience a hard to start concern when attempting to start the engine. This may be caused by carbon deposits on the spark plugs, or fuel flooding during engine start due to improper PCM software calibration. A revised PCM calibration which reduces the fuel amount at the time of engine start is part of PROCEDURE "D" PCM REPROGRAMMING.

It is NOT necessary to replace the spark plugs when the recall is performed on new vehicle inventory, because they will be replaced later during the FINAL QUALITY INSPECTION. Vehicles that have NOT had spark plugs replaced within the past 12 months of the recall inspection date, will require leading spark plug replacement.

CATALYTIC CONVERTER INSPECTION

Some vehicles may have degraded catalytic converters due to "ENGINE DIFFICULT TO START" concern. An inspection of the vehicle's OBD data MODE 6 data is required to determine if catalytic converter replacement is necessary.

PROCEDURE "A" - CATALYTIC CONVERTER INSPECTION

NOTE:

- You must perform catalytic converter inspection first before reprogramming the PCM. PCM reprogramming will erase MODE 6 test results.
 - Be sure to fill in the CATALYTIC CONVERTER PARTS ORDER FORM with the information gathered from the following procedure to use if engine replacement is necessary.
1. Using IDS, access "MODE 6 on-board test results" from "OBD test modes" menu. Check test results for "CATALYST MONITOR BANK 1".

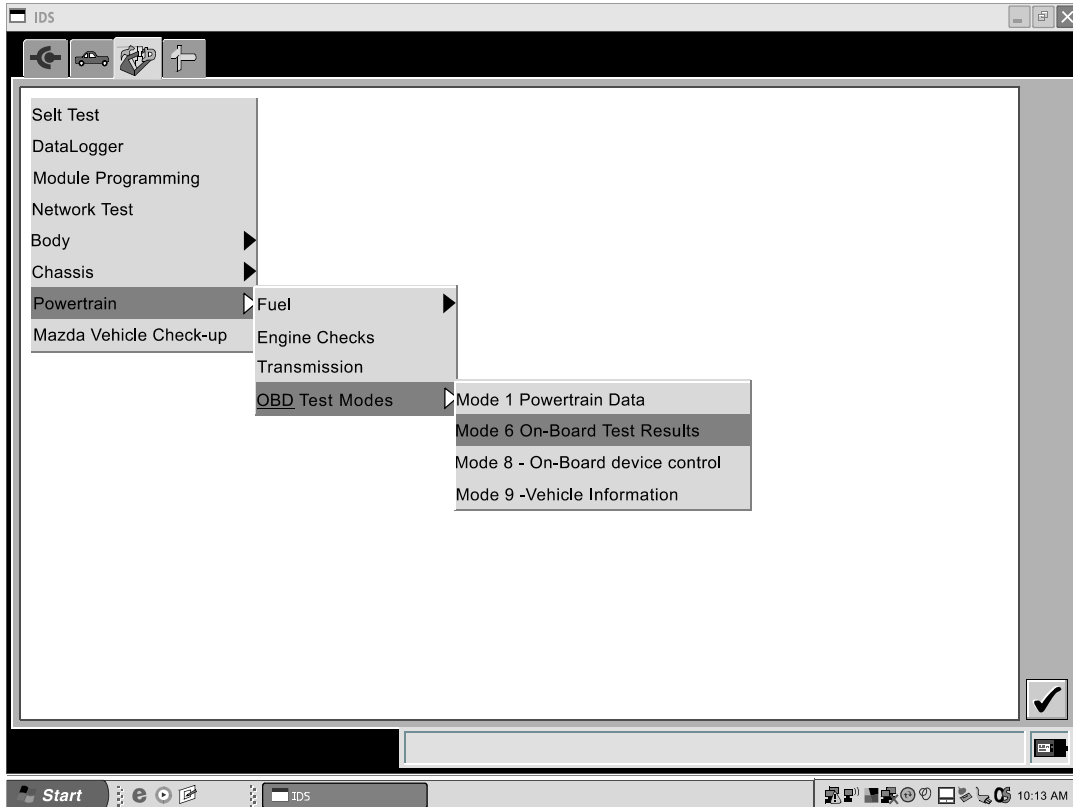

The screenshot shows the IDS software interface displaying a table of OBD test results. The table has columns for Description, QBDMID, Test ID, Min, Max, and Value. The status bar at the bottom indicates 'Complete'.

Description	QBDMID	Test ID	Min	Max	Value
HO2SB1S1 Monitor	1				
HO2SB1S1 Voltage Amplitude	1	80	0.5:1	256:1	1.05:1
HO2SB1S1 Heater Current	1	81	0.33:1	256:1	1.23:1
HO2SB1S2 Monitor	2				
Unknown Test ID	2	3	0.299V	0.299V	0.299V
Unknown Test ID	2	4	0.400V	0.400V	0.400V
Unknown Test ID	2	5	0s	0.080s	0.032s
Catalyst Monitor Bank 1	21				
Rear-to-Front Switch Ratio	21	80	0:1	8:1	0.51:1
EVAP Monitor (Large Leak)	3A				
Phase 0 Excessive Vacuum Limit	3A	80	0.699mA	255.996mA	2.363mA
EVAP Monitor (0.040 inch)	3B				
Phase 20.040 inch Cruise Leak Check Vacuum Bleedup And Maximum 0.040 inch Leak Threshold	3B	80	2.363mA	255.996mA	2.363mA
EVAP Monitor (0.020 inch)	3C				
Phase 20.020 inch Idle Leak Check Vacuum Bleedup And Maximum Leak Threshold	3C	80	0.073	1.998	0.106
Unknown Monitor	3D				
Unknown Test ID	3D	80	0mA	16.882mA	16.796mA
Secondary Air Monitor (Bank1)	71				
HO2SB1S1 Rich During Flow Test	71	80	0s	4.992s	0s
Misfire Cylinder 1 Data	A2				
EWMA misfire counts for last 10 drive cycles	A2	B	0counts	65535counts	4counts
Misfire counts for last/current drive cycle	A2	C	0counts	65535counts	0counts
Misfire Cylinder 2 Data	A3				
EWMA misfire counts for last 10 drive cycles	A3	B	0counts	65535counts	4counts
Misfire counts for last/current drive cycle	A3	C	0counts	65535counts	0counts
Thermostat	E1				

4206b

**ATTACHMENT II
RECALL 4206F**

Description	OBDMID	Test ID	Min	Max	Value
Catalyst Monitor Bank 1	21				
Rear-to-Front Switch Ratio	21	80	0:1	8:1	0.51:1

4206c

- Is the measured test result "VALUE" number MORE or LESS than 4.60:1?
 - LESS THAN 4.60:1** - Catalytic converter OK, proceed to PROCEDURE "B" ENGINE DIFFICULT TO START.
 - MORE THAN 4.60:1** - Catalytic converter failed, record result on CATALYTIC CONVERTER REPLACEMENT PARTS ORDER FORM and refer to PARTS INFORMATION section for catalytic converter parts ordering process. Replace catalytic converter and proceed to PROCEDURE "B" ENGINE DIFFICULT TO START.

NOTE:

- Some vehicles will indicate a MIN, MAX and VALUE of "0". Proceed to PROCEDURE "B" ENGINE DIFFICULT TO START if you receive this result.

Description	OBDMID	Test ID	Min	Max	Value
Catalyst monitor Bank 1	21				
Rear to front switch ratio	21	80	0	0	0

4206p

PROCEDURE "B" - ENGINE DIFFICULT TO START

1. Replace leading spark plugs **ONLY**.

NOTE:

- Spark plug replacement is **NOT** required when:
 - The recall is performed on new vehicle inventory, because they will be replaced later during the FINAL QUALITY INSPECTION (FQI).
 - Vehicles that have had leading spark plugs replaced and/or the FQI performed within the past 12 months of the recall inspection date.

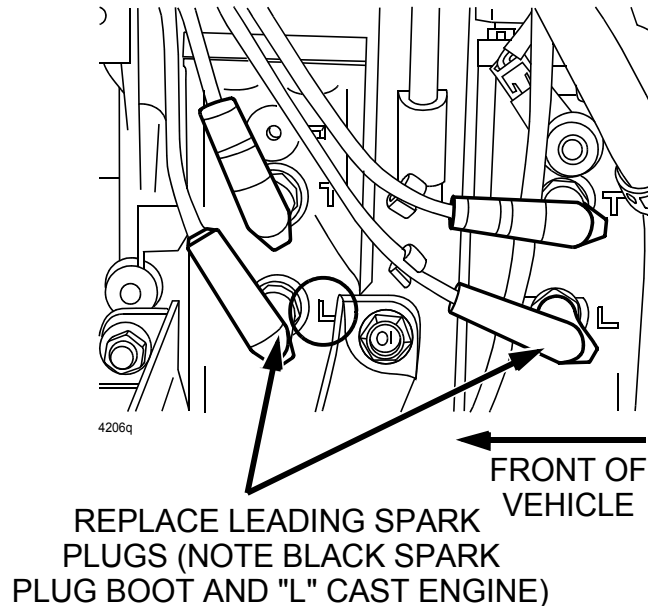

PROCEDURE "C" - DRIVABILITY CONCERNS

NOTE:

- Review warranty / repair history for the customer's vehicle for previous engine replacements or repairs due to severe lack of power / low idle concern before continuing with this procedure. Also, check with customer if they are currently experiencing a severe lack of power / low idle concern.

Some vehicles may experience a severe lack of power and low idle concerns when driven in high ambient temperatures / low humidity conditions. This may be caused by improper PCM software calibration which controls the metering oil injection amount, which may result in poor sealing of the engine's combustion chambers. Since this concern occurs in a limited area of the country, most customers will not experience the severe lack of power / low idle concern.

Although all vehicles require the revised PCM calibration, it is not necessary to perform the engine inspection procedure on all vehicles. Use the following steps to determine the need to perform the engine inspection procedure.

Use the following decision chart to determine which procedure to use.

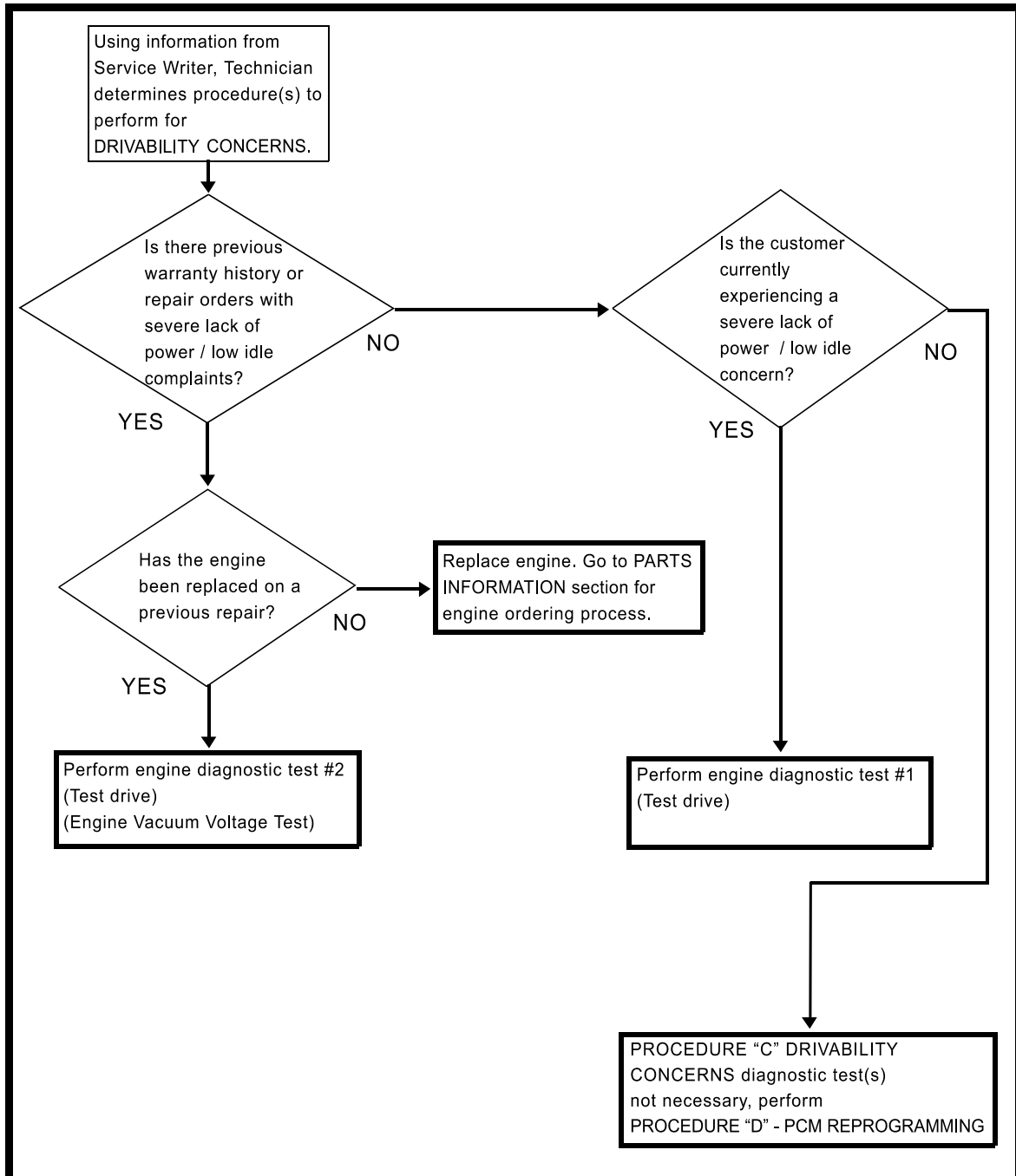

4206d

ENGINE DIAGNOSTIC TEST # 1

NOTE:

- Be sure to fill in the ENGINE REPLACEMENT PARTS ORDER FORM with the information gathered from the following procedure to use if engine replacement is necessary.

1. Perform test drive lasting at least 20 minutes following these guidelines:
 - Drive vehicle on city streets at speeds below 45 mph.
 - Air conditioning and fan speed on max.
 - Accelerate at very light throttle keeping shift points below 3000 RPM.

**ATTACHMENT II
RECALL 4206F**

- After 10 minutes stop vehicle in a parking lot, M/T in neutral and A/T in drive for one minute, and monitor engine RPM using the DATALOGGER PID.
 - At the 20 minute mark, stop the vehicle in a parking lot, M/T in neutral and A/T in drive for one minute, and monitor engine RPM using the DATALOGGER PID.
 - Safely accelerate the vehicle at wide open throttle (M/T shift at 8000 RPM) to the legal speed limit.
2. Did you experience any of the following during the test drive?
- Engine stall
 - The vehicle has a severe lack of power
 - The RPM PID drops to below 700 RPM during the one minute stops.

NO – Proceed to REPAIR PROCEDURE “D” PCM REPROGRAMMING

YES – Engine replacement required, complete ENGINE REPLACEMENT PARTS ORDER FORM and refer to PARTS INFORMATION section for engine ordering process.

ENGINE DIAGNOSTIC TEST # 2

NOTE:

- Be sure to fill in the ENGINE REPLACEMENT PARTS ORDER FORM with the information gathered from the following procedure to use if engine replacement is necessary.
1. Start engine, warm ECT to 195F.
 2. Perform METERING OIL PUMP (MOP) simulation test.
 3. Using DATALOGGER, select MOP POS# and RPM.

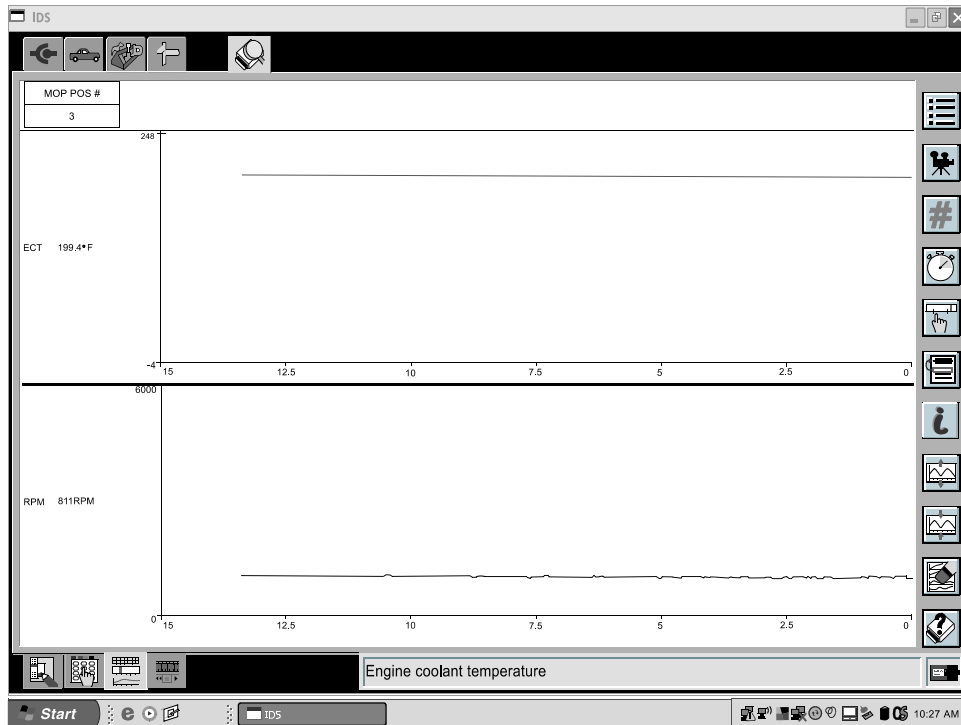

4206e

- A. Click on MOP POS# PID.
- B. Click on “#” symbol.
- C. Click “finger” symbol.
- D. Click on “+ arrow up” symbol until MOP POS# indicates “60”.

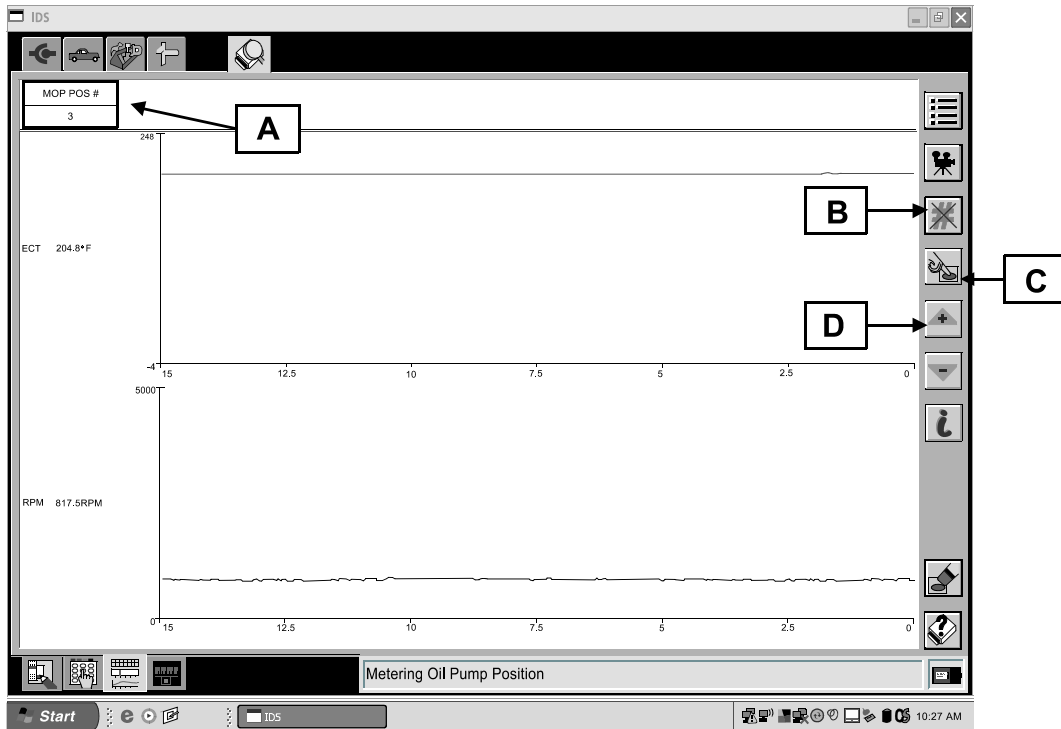

4206f

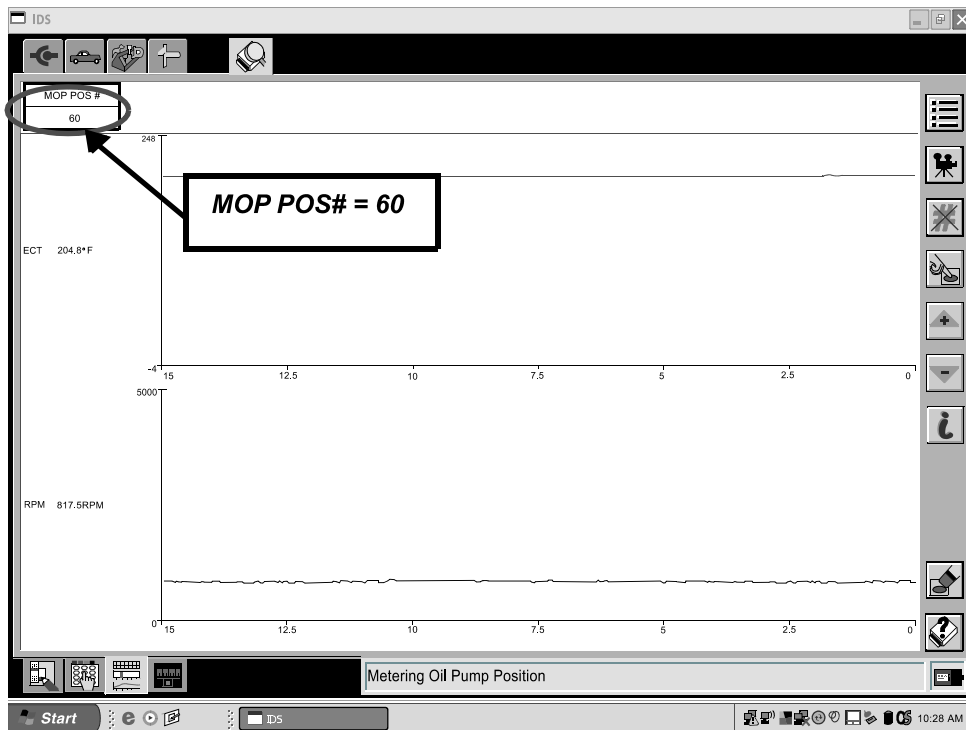

4206g

**ATTACHMENT II
RECALL 4206F**

4. Allow engine to idle for 8 minutes with MOP POS # at step 60.

NOTE:

- Make sure transmission is in NEUTRAL or PARK and all loads OFF (AC, blower etc.), do not touch accelerator pedal during this time or test will abort.
5. Tap accelerator pedal after the 8 minutes have elapsed to abort test. MOP POS# will drop from step #60.
 6. Allow engine to idle for 5 minutes.
 7. Perform test drive lasting at least 20 minutes following these guidelines:
 - Drive vehicle on city streets at speeds below 45 mph.
 - Air conditioning and fan speed on max.
 - Accelerate at very light throttle keeping shift points below 3000 RPM.
 - After 10 minutes stop vehicle in a parking lot, M/T in neutral and A/T in drive for one minute, and monitor engine RPM using the DATALOGGER PID.
 - At the 20 minute mark, stop the vehicle in a parking lot, M/T in neutral and A/T in drive for one minute, and monitor engine RPM using the DATALOGGER PID.
 - Safely accelerate the vehicle at wide open throttle (M/T shift at 8000 RPM) to the legal speed limit.
 8. Did you experience any of the following during the test drive?
 - The vehicle has a severe lack of power
 - The RPM PID drops to below 700 RPM during the one minute stops.

NO – Proceed to ENGINE VACUUM VOLTAGE TEST.

YES – Engine replacement required, complete ENGINE REPLACEMENT PARTS ORDER FORM and refer to PARTS INFORMATION section for engine ordering process.

ENGINE VACUUM VOLTAGE TEST

NOTE:

- This test is ONLY necessary if the vehicle does not have any symptoms described in step #8 of ENGINE DIAGNOSTIC TEST # 2.

IMPORTANT:

- This test must be performed immediately after test drive. The engine must be HOT for accurate results.

This test is performed using SST # N3M1-18-791 (Manifold Vacuum Tester). You will also need to use WDS or FLUKE meter to measure voltage.

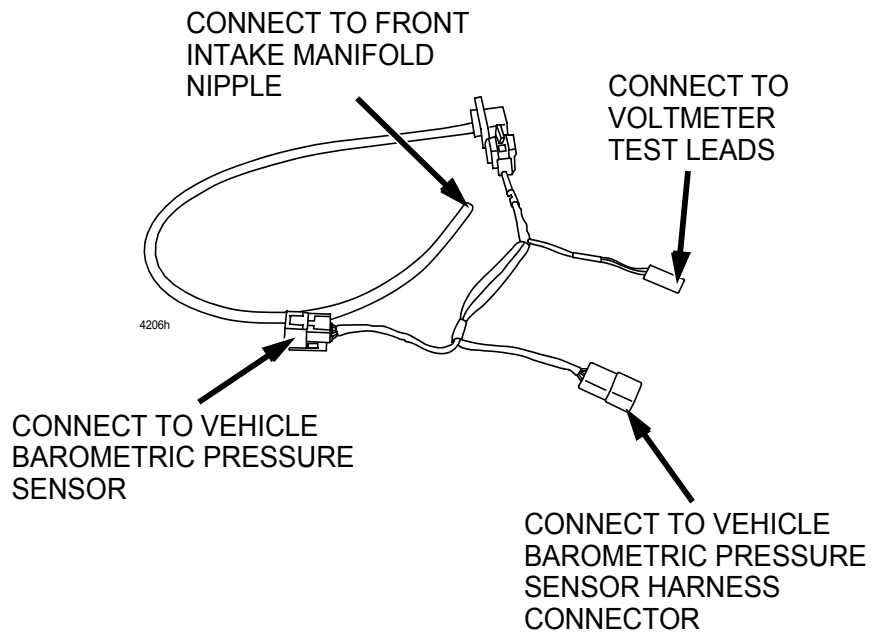

1. With ignition "OFF", remove blind plug from front intake manifold nipple.

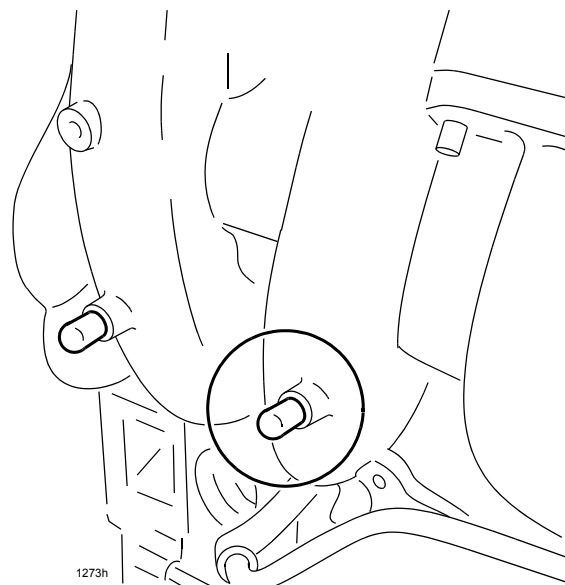

2. Attach vacuum hose from SST to intake manifold nipple.

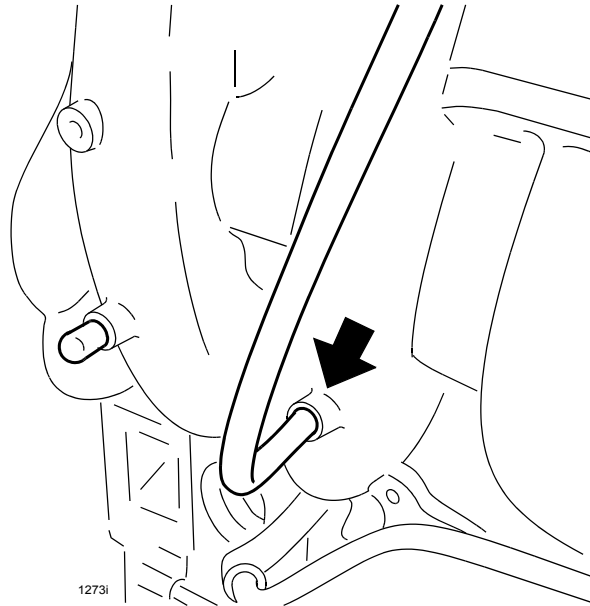

3. Disconnect vehicle barometric pressure sensor connector.

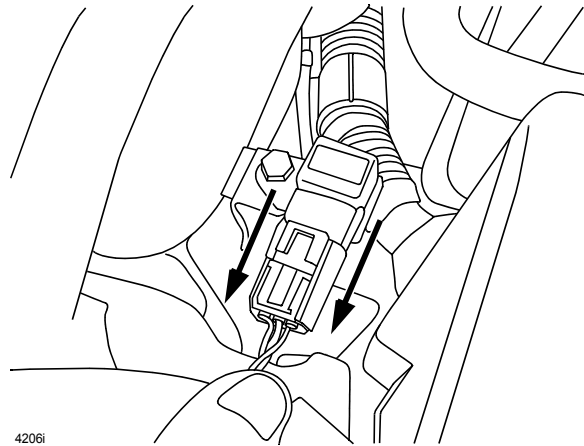

4. Connect SST to vehicle barometric pressure sensor and barometric pressure sensor connector.

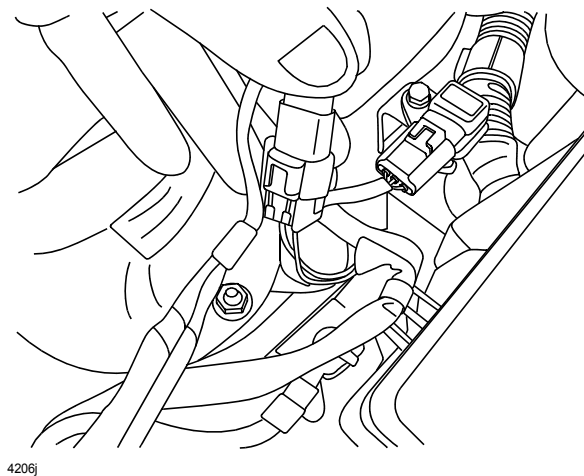

**ATTACHMENT II
RECALL 4206F**

5. Connect positive lead of WDS (or FLUKE meter) to red wire of SST, and negative lead of WDS (or FLUKE meter) to black / green wire of SST.

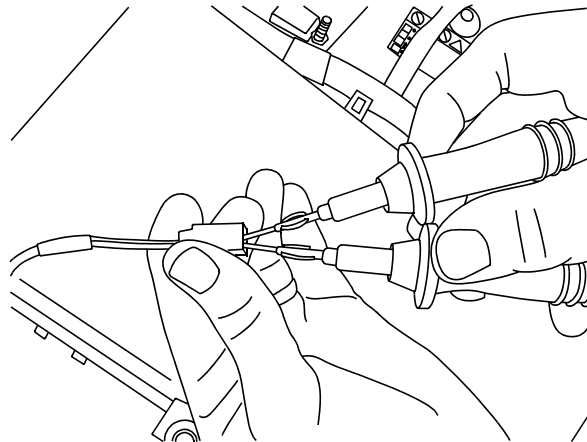

4206k

6. Turn ignition to "ON" position but do not start engine.
7. Access "DIGITAL MULTIMETER" from tool box menu of WDS.

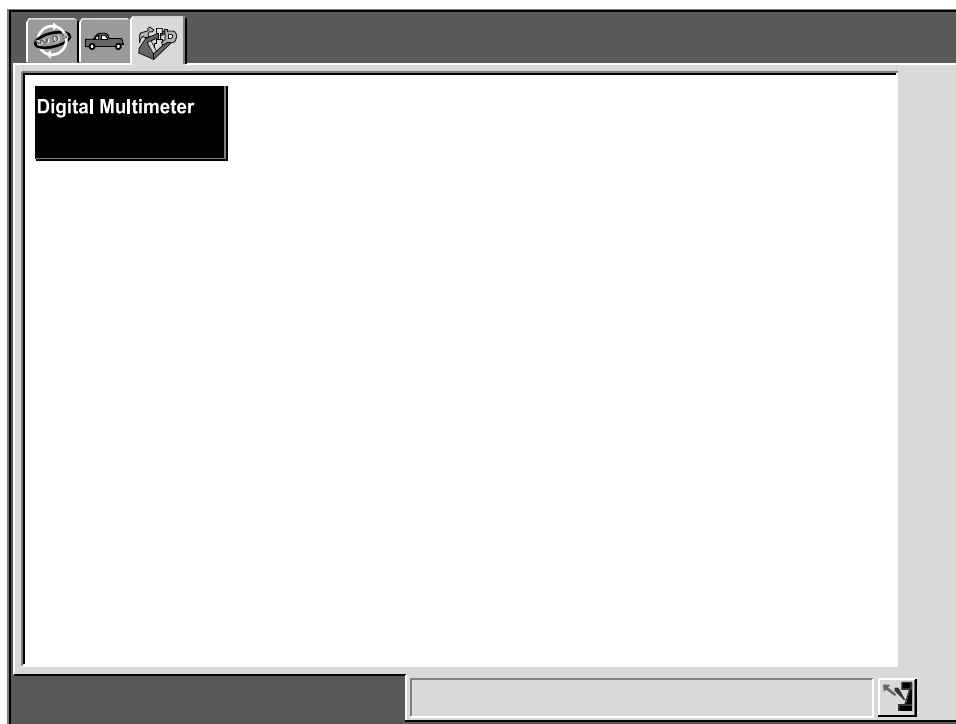

4206l

**ATTACHMENT II
RECALL 4206F**

8. Using DC volt scale of WDS digital multimeter or FLUKE meter, record voltage reading on the ENGINE REPLACEMENT PARTS ORDER FORM as “BARO” voltage.

NOTE:

- Make sure to document voltage reading EXACTLY as shown on the meter display to the “hundredth” position.
- **Voltage reading will vary depending on altitude of vehicle at time of testing.**

WDS MULTIMETER

SELECT THIS
BUTTON FOR
DC VOLTS

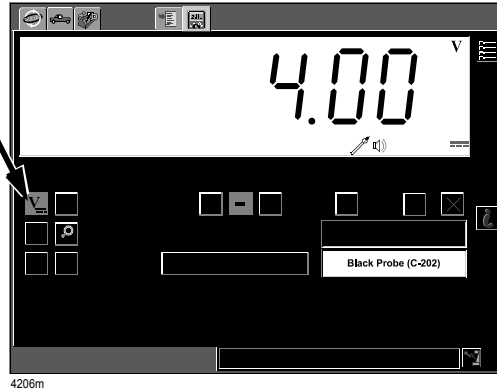

FLUKE METER

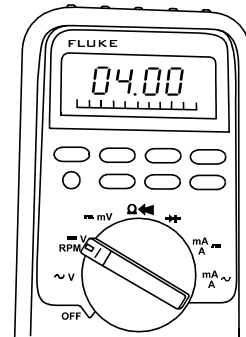

9. Start engine, idle for 5 minutes with all loads (air conditioning, stereo, etc.) OFF and transmission shift lever in PARK or NEUTRAL.
10. Record voltage reading on the attached ENGINE REPLACEMENT PARTS ORDER FORM as “IDLE” voltage.

NOTE:

- Make sure to record the voltage reading ONLY when the engine cooling fans are OFF.
- Make sure to document voltage reading EXACTLY as shown on the meter display to the “hundredth” position.
- **Voltage reading will vary depending on engine condition.**

WDS MULTIMETER

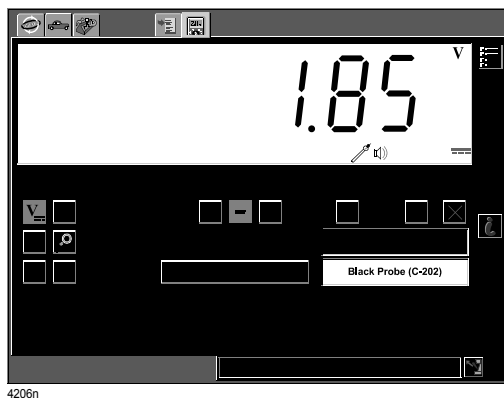

FLUKE METER

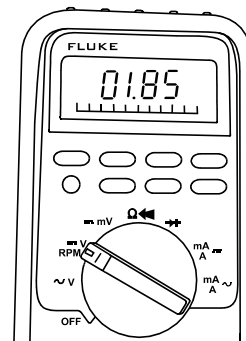

NOTE:

- Use the information from the **ENGINE REPLACEMENT PARTS ORDER FORM** to complete the MX Connect on-line diagnostic information required to determine engine replacement. After information has been entered into the on-line system, a message will be displayed informing you if engine replacement is necessary. If engine replacement is necessary, your order will be reviewed and e-mail confirmation of the engine parts order will be sent.

PROCEDURE “D” - PCM REPROGRAMMING

1. Reboot the PDS/IDS to clear memory before reprogramming.
2. Using PDS/IDS 44.7 or later software, reprogram the PCM to the latest calibration (refer to “Calibration Information” table) by following the “Module Reprogramming” procedure.

NOTE:

- Always update the PDS/IDS tool first, then follow on-screen instructions to download the needed calibration file for PCM reprogramming.
 - It is not necessary to remove any fuses or relays during PCM reprogramming when the PDS/IDS screen prompts you to do so. You may accidentally stop power to one of the PCM terminals and cause the PCM to be blanked, or you may receive error messages during the PDS/IDS reprogramming procedure.
 - PDS/IDS shows the calibration part numbers after programming the PCM.
 - Please be aware that PCM calibration part numbers and file names listed in any SSP or recall may change due to future releases of PDS/IDS software, and additional revisions made to those calibrations for service related concerns.
 - When reprogramming a PCM, PDS/IDS will always display the “latest” calibration P/N available for that vehicle. If any calibration has been revised/updated to contain new information for a new service concern/issue, it will also contain all previously released calibrations.
 - **When performing this procedure, we recommend that a battery charger be installed on the vehicle battery and turned ON to a maximum charge of no more than 20 AMPS to keep the vehicle battery up to capacity. If you exceed 20 AMPS, it could damage the VCM.**
3. After performing the PCM reprogramming procedure, verify the repair by starting the engine and making sure there are no MIL illumination or abnormal warning lights present.

NOTE:

- If any DTCs should remain after performing DTC erase, diagnose the DTCs according to the appropriate Troubleshooting section of the Workshop Manual.
 - After PCM reprogramming, it is no longer necessary to road test the vehicle to “relearn” KAM (Keep Alive Memory).
4. Fill out an “Authorized Modifications” label (P/N 9999-95-AMDC-97) with the new PCM calibration information, your dealer code, and today’s date.

mazda AUTHORIZED MODIFICATIONS
THESE MODIFICATIONS HAVE BEEN APPROVED, AS APPROPRIATE, BY THE EPA AND CARB.
THE FOLLOWING MODIFICATIONS HAVE BEEN MADE:

1326c

5. Place the “Authorized Modifications” label on the “A” pillar below the tear tag in the driver door jamb.

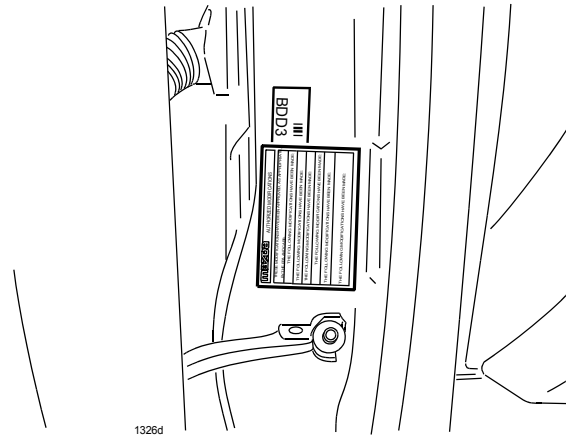

CALIBRATION INFORMATION

Year	Transmission (Emission Type)	New PCM Calibration Part Number	File Name
2004	A/T (All)	N3Z1-18-881U	SW-N3Z1EU000
2004	M/T (All)	N3Z2-18-881T	SW-N3Z2ET000
2005	A/T (Fed)	N3ZA-18-881H	SW-N3ZAEH000
2005	M/T (Fed)	N3ZB-18-881G	SW-N3ZBEG000
2005	A/T (Cal)	N3ZC-18-881H	SW-N3ZCEH000
2005	M/T (Cal)	N3ZD-18-881G	SW-N3ZDEG000
2006	A/T (Fed)	N3M6-18-881F	SW-N3M6EF000
2006	M/T (Fed)	N3M5-18-881F	SW-N3M5EF000
2006	A/T (Cal)	N3M2-18-881F	SW-N3M2EF000
2006	M/T (Cal)	N3M1-18-881F	SW-N3M1EF000

NOTE: The PCM Calibration Part Numbers listed above are provided for PCM reprogramming purposes only. These are not necessarily the same Mazda part numbers used to order an actual PCM through the Mazda Parts System. It is not necessary to order a PCM as part of this repair procedure.

PARTS INFORMATION

Part Number	Description	Qty.	Notes
N3Z4-18-110	Leading spark plug	2	NGK RE7C-L, standard heat range #7
N3Y1-20-SA0	Catalytic converter kit	1	Includes: (1) N3H4-20-55XL catalytic converter (1) N3H1-40-305 gasket (3) 9YB1-01-004 nuts
K008-99-008R-54	AT engine	1	2004-2005 Remanufactured short engine, automatic transmission models.
K008-99-008R-55	MT engine	1	2004-2005 Remanufactured short engine, manual transmission models.

PARTS ORDERING / AUTHORIZATION PROCESS FOR CATALYTIC CONVERTERS / ENGINES

Order replacement catalytic converter and / or engine using MX Connect website. Complete the attached CATALYTIC CONVERTER PARTS ORDER FORM and ENGINE REPLACEMENT PARTS ORDER FORM as required. Use the following menus to order.

- Log on to <https://portal.mazdausa.com/prod2/MXConnect>.
- Click on "Parts and Accessories" located on the top menu bar.
- Under "Support" on the right side of the screen click on "RX-8 Recall 4206F Parts Ordering".
- Fill in the required data using the information on the following order forms.

CATALYTIC CONVERTER PARTS ORDER FORM

Use this form to fill in information on MX Connect website if it is necessary to order a catalytic converter.

- Log on to MX Connect.
- Click on "Parts and Accessories" located on the top menu bar.
- Under "Support" on the right side of the screen click on "RX-8 Recall 4206F Parts Ordering".
- Click on "Catalytic Converter".
- Fill in the required data using the information from this form.

VIN

MILEAGE

CATALYTIC CONVERTER TEST RESULTS

Description	OBDMID	Test ID	Min	Max	Value
Catalyst Monitor Bank 1	21				
Rear-to-Front Switch Ratio	21	80	0:1	8:1	

ENTER THE MODE 6 VALUE FROM THE OBD ON BOARD
TEST RESULTS IN THE BOX BELOW

ENGINE REPLACEMENT PARTS ORDER FORM

Use this form to fill in information on MX Connect website if it is necessary to order an engine.

Complete form only as directed by the repair instructions.

- Log on to MX Connect.
- Click on "Parts and Accessories" located on the top menu bar.
- Under "Support" on the right side of the screen click on "RX-8 Recall 4206F Parts Ordering".
- Click on "Engine".
- Fill in the required data using the information from this form. You will automatically be directed to the next item as the data is entered.

Form may not be completely filled out depending on vehicle diagnosis.

VIN

MILEAGE

1. Vehicle repair history

- | | YES | NO |
|--|--------------------------|--------------------------|
| a. Are there previous warranty history or repair orders with severe lack of power / low engine idle complaints?
- YES, note number of repair attempts, go to 1b <input style="width: 50px;" type="text"/>
- NO (1 st repair attempt), enter "1", go to 1c | <input type="checkbox"/> | <input type="checkbox"/> |
| b. Has the engine been replaced on a previous repair?
- YES, note RO or Warranty Claim #, go to 2 <input style="width: 100px;" type="text"/>
- NO, replace engine | <input type="checkbox"/> | <input type="checkbox"/> |
| c. Is the customer currently experiencing severe lack of power / low engine idle?
- YES, go to 2
- NO, go to PROCEDURE "D" PCM PROGRAMMING | <input type="checkbox"/> | <input type="checkbox"/> |

2. Did you experience any of the following during test drive?

- | | YES | NO |
|--|--------------------------|--------------------------|
| a. Severe lack of engine power
- YES, replace engine
- NO, go to 3 | <input type="checkbox"/> | <input type="checkbox"/> |
| b. RPM PID drops below 700 during the 1 minute stops
- YES, replace engine
- NO, go to 3 | <input type="checkbox"/> | <input type="checkbox"/> |

3. Vehicle test results (required ONLY if engine was previously replaced)

Engine vacuum voltage test results (necessary only if engine vacuum test was performed)

BARO Voltage

IDLE Voltage

©2006 Mazda Motor Corporation

C. CAMPAIGN LABEL INSTALLATION

Complete a "Campaign Label" with the recall number written on the sticker and affix it to the vehicle's hood or bulkhead. Refer back to the illustration under "A. VEHICLE INSPECTION PROCEDURE".