

RX-8 RAM AIR DUCT Installation Instructions

Tools Required:

Flat Head Screw Driver
Phillips Head Screw Driver & Stubby
10mm Socket and Ratchet
10mm Open End Wrench
12mm Socket & Ratchet and Extension

Estimated time required: 1 Hour

People Required: 1

NOTE: These instructions assume that the RB REV*i* Intake (PN 16399) has already been installed. Proceed to Step 2 (on Page 2) if the nose is already removed from the car.

Step 1- Nose Removal

I. Raise the hood of the car. Turn steering wheel as far as possible to one side.

II. Remove the upper plastic panel as shown in Photo A. Use a small flat head screwdriver to remove the six (6) plastic clips by prying between the head and body of the fastener. Remove the panel, which now reveals the bumper upper retaining fasteners.

III. Remove the four (4) 10mm head bolts from the top of the bumper. Gently pry up the head of the (2) plastic clips with a small screwdriver, then remove them. See Photo B.

IV. Proceed to the wheel wells and using the small Phillips head screwdriver, remove the plastic clips along the edge of the bumper as shown in Photo C.

V. Remove the sheet metal screws (1 screw per lamp) that retain the corner lamps (Photo D), then gently pry the lamp away from the nose. (See attachment point in Photo E1). Next, rotate the bulb fixture and remove the fixture from the corner lamp. (Photo E2) Carefully push the lamp socket through the opening in the nose.

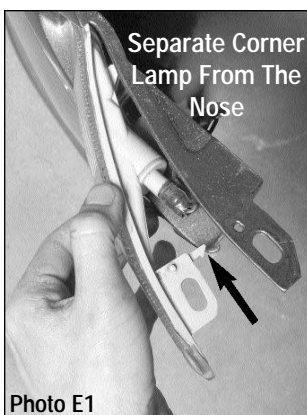
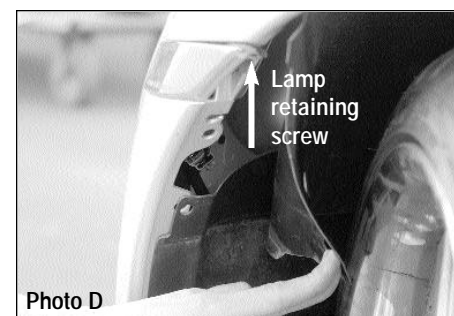
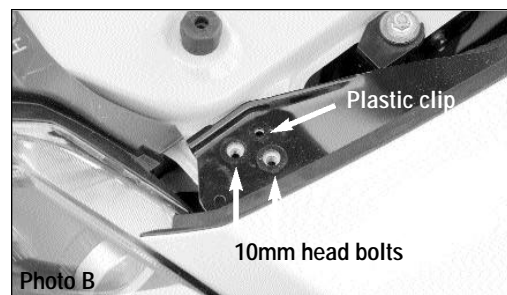
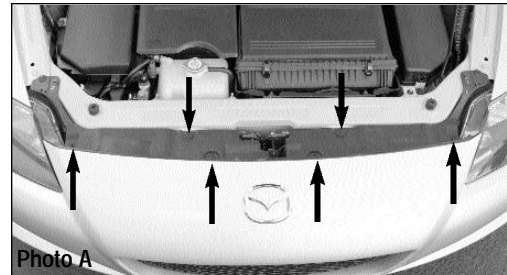

VI. Remove the ten (10) sheet metal screws from the front bottom edge of the bumper. Note the sizes of these screws for the later replacement. See Photo F for location of these screws. (If your car is equipped with the factory chin spoiler, do not remove the fasteners that secure it to the chassis.)

VII. Disconnect the electrical connectors from the fog lights (if installed) by pulling the bottom plastic panel downward and reaching up under the bumper to access the electrical connectors.

IIX. Gently remove the bumper by “peeling” the sides away from the chassis (starting with the corners nearest the corner lamps), then pull the bumper forward.

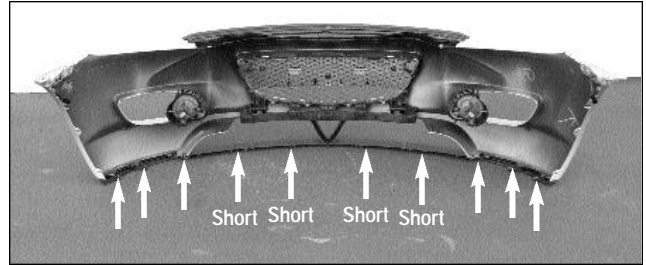

Photo F

Step 2

Remove the Styrofoam pad, taking note of the orientation, from the front of the bumper bar (2 Phillips head plastic clips), then remove the black plastic nose support panel (3 plastic clips). See Photo G.

Step 3

Removal Of The Intake Duct Assembly

(Proceed to Step 4 if Intake Duct has already been removed.)

Manual Transmission: Remove the bolt, (3) plastic clips, and vacuum hose connection; then remove the VFAD (Variable Fresh Air Duct) unit. (VFAD will not be used.) See Photo H1.

Auto Transmission: Remove the retaining bolt, (2) plastic clips, then remove the duct assembly. The duct will not be reused. (See Photo H1 for location of the bolt and plastic clips.)

Hint: Remove the duct by pulling the unit forward while rocking the assembly from side-to-side. Photo H2.

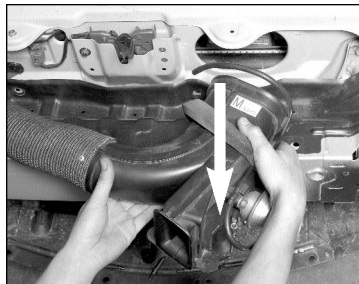

Photo H2 - VFAD unit shown

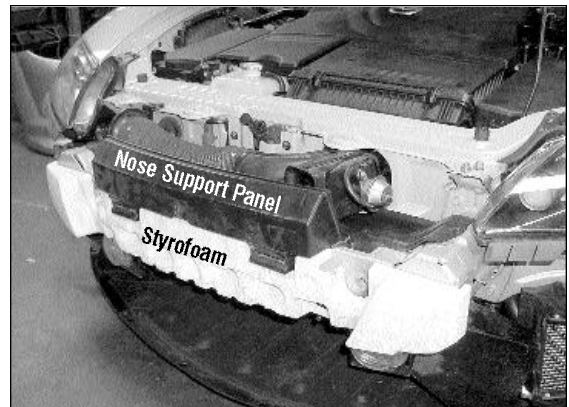

Photo G

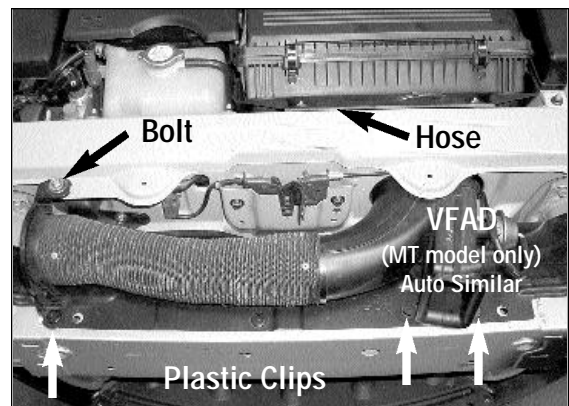

Photo H1 - Manual transmission model shown

Step 4

Remove the black plastic panel (plastic clips) - this part will not be reused. See Photo I

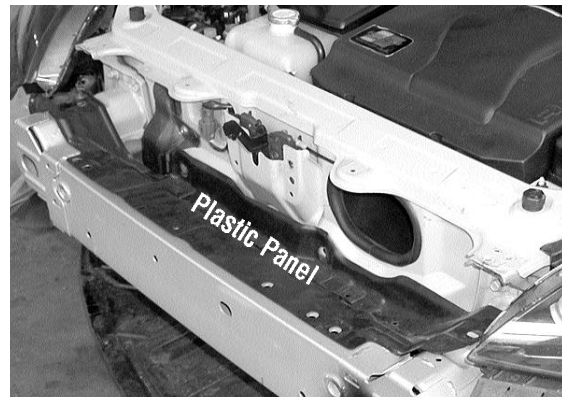

Photo I

Step 5

Follow the wire leading to the air temperature sensor under the bumper bar, and detach the plastic clip that is mounted on the rear of the bumper bar. See Photo J (This will not be reattached.)

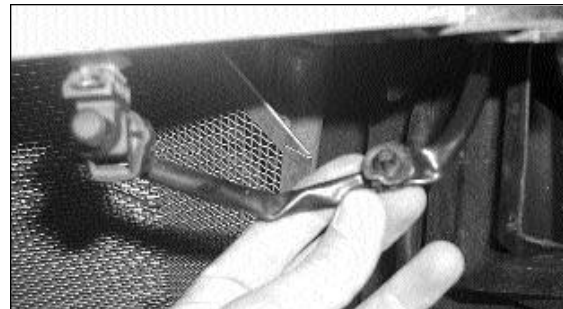

Photo J

Step 6 (See Photo K)

Tighten the passenger side 6mm bolt (A) as indicated. This will ensure that the hood latch will remain in its position for the next step. Remove the driver side 6mm bolt as indicated as (B).

Remove the (4) 8mm bumper support bolts (C). Also refer to Photos L & M. (These bolts will be reused.)

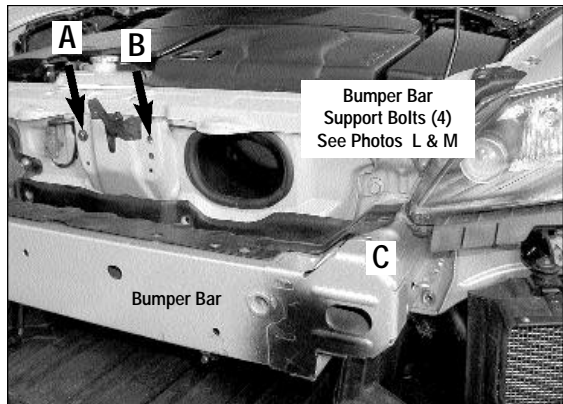

Photo K

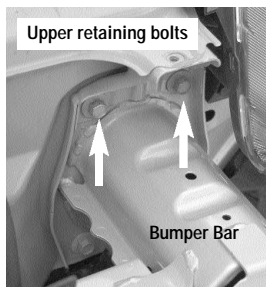

Photo L

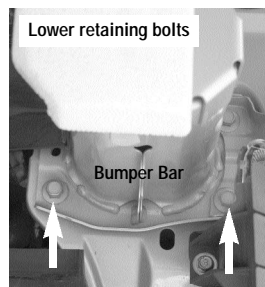

Photo M

Step 7

Loosely install the large angle bracket onto the plastic duct with the supplied (2) 6mm short bolts as shown in Photo N. (The lowest hole position on the duct will not be used).

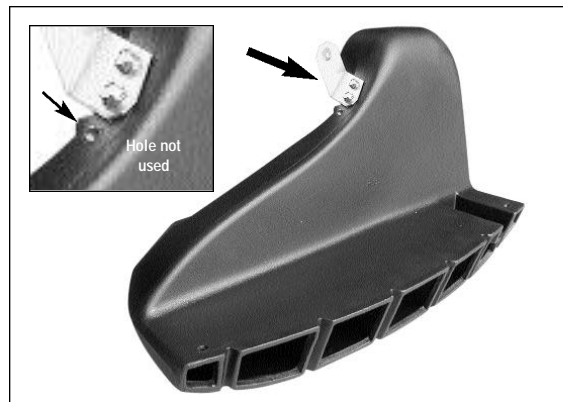

Photo N

Step 8

Install the cold air duct by first pulling the bumper bar (driver side) slightly away from the chassis and then inserting the duct under the bumper bar as shown in Photo O. Be careful not to push the lower edge of the foam seal (installed with the air box) out of position with the lower edge of the duct. Tighten the upper L-bracket to the chassis with the original 6mm bolt removed from Step 6.

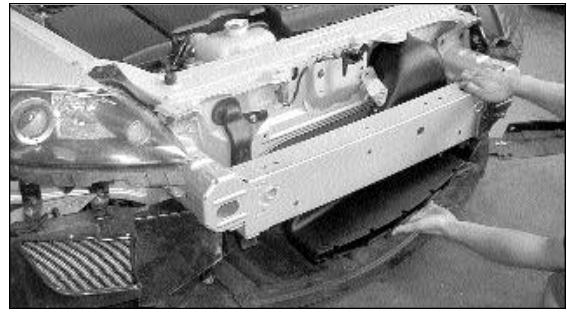

Photo O

Step 9

Install and tighten the (4) 8mm bumper bar bolts that were removed in Step 6. To assure correct positioning of the bumper bar, lift and align the bar to the original marks left by the bolts. Torque to 12-15 ft/lbs.

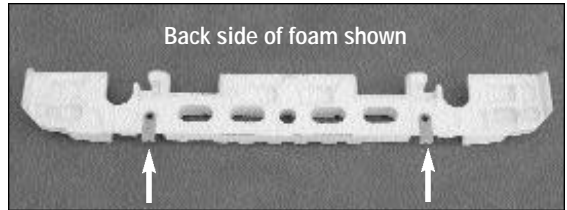

Photo P

Step 10

Install the black plastic nose support panel that sits on top of the bumper bar with the three original plastic fasteners.



Photo Q

Step 11

Install the (2) supplied small L-brackets to the back side of the Styrofoam panel using the original attachment clips as shown in Photo P & Q. (Back side of Styrofoam shown). Re-install the Styrofoam panel to bumper bar using the two original retaining fasteners.

Step 12

Reach into the mouth of the duct and insert a supplied long 6mm bolt up through the hole in one outer corner of the duct (see locations in Photo R) and loosely retain it with a supplied nut as shown in Photo S. (The bolt will extend upward through the duct and metal L-bracket mounted to the bumper support.) Repeat on the opposite outer corner of the duct. Note: Make certain that the outlet of the plastic duct is centered over the foam seal and up against the sheet metal. Tighten the bolts in place.

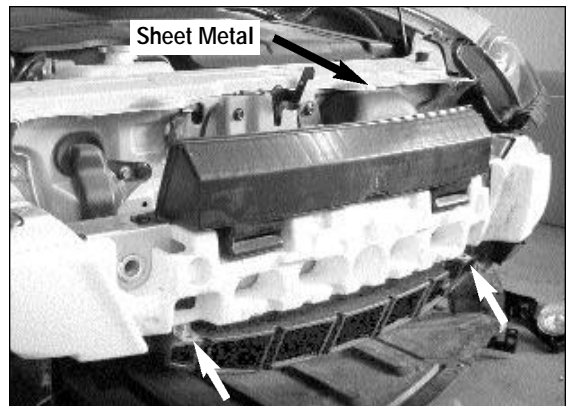

Photo R

Fully tighten the (2) short 6mm bolts on the large L-bracket on the top of the duct. (Do not over tighten)

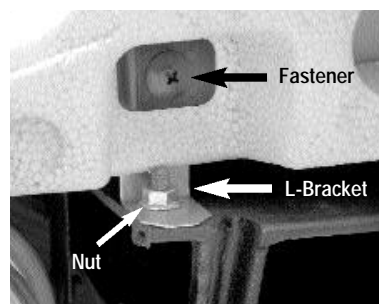

Photo S - Cut-a-way view of duct.

Step 13

Re-install the front bumper cover.

© Racing Beat, Inc 2005