

UltraGauge EM

INSTALLATION & OPERATION

Version 1.1

WARNINGS

Information in this document is subject to change without notice. Ultra-Gauge.com reserves the right to change or improve its products and to make changes in the content without obligation to notify any person or organization of such changes, additions or improvements. Always visit Ultra-Gauge.com for the latest updates concerning the installation, use and operation of this product.



Failure to avoid the following potentially hazardous situations can result in an accident or collision resulting in death or serious injury

INSTALLATION WARNINGS

- When installing UltraGauge in your vehicle, place UltraGauge so that it does not obstruct the driver's view of the road or ability to operate the vehicle.
- Extreme care must be taken when routing the OBD II cable. Avoid routing and installing in such a fashion that the cable can interfere with any of the foot controls, steering wheel, or other vehicle controls, or represent an entry or exit hazard to the driver. Always secure excess or loose cable so that feet and hands do not become entangled.
- The windshield mount or Velcro mount may not stay attached under all conditions. Do not mount UltraGauge where it will become a distraction or hazard should it become detached.
- Do not mount UltraGauge in an area that may interfere with the deployment of airbags. Consult your vehicle's owner's manual.
- UltraGauge in rare circumstances may impair select vehicle systems. See the Forced Protocol section for more information and resolution.
- The optional locking ring supplied with the windshield mount should normally not be used and is only for the very rare case that the ball swivel is not tight enough to hold the position of UltraGauge. Use of the ring will result in increased force necessary to adjust the position of UltraGauge and if improperly used may result in damage. If used, it should be adjusted so that the balls swivel offers a very slight resistance to movement.

OPERATION WARNINGS

- Never attempt to operate UltraGauge controls while the vehicle is moving. Not only is this extremely hazardous, UltraGauge stops performing mileage, distance and other calculations while the menu system is active.
- Never become distracted by UltraGauge while driving.

Liability

The use of UltraGauge is at your own risk. Ultra-Gauge.com shall in no event be liable for any damages, whether direct or indirect, special or general, consequential or incidental, arising from any loss claimed as a result of the use of UltraGauge.

Battery Warning

This product contains no batteries

Fuse Warning

This product is equipped with a fuse. The fuse is integrated in the male OBD-II connector and cannot be accessed or replaced. This fuse provides protection against potential short-circuit conditions within UltraGauge and short-circuits introduced into the cable.

NOTICES

Windshield Mounting Legal Notice

Some State laws and ordinances prohibit mounting devices to the windshield or any areas that obstruct visibility. It is the user's responsibility to check state and local laws and ordinances before mounting UltraGauge to insure compliance with all applicable laws and ordinances. Where the windshield mount is prohibited, the Velcro mount can be used to mount UltraGauge in an area compliant with applicable laws and ordinances.

FCC Compliance

This device complies with part 15 of the FCC rules

Rights and Obligations

The software contained in UltraGauge may not be copied, transferred or disassembled and used in part or in whole. The artwork used in the generation of UltraGauge electrical circuitry may not be replicated in part or in whole without express written permission from UltraGauge.com, Inc.

Limited Warranty

UltraGauge is warranted to be free from defects in materials and workmanship for one year and the windshield mount for 6 months from the date of purchase. Within this period, Ultra-Gauge.com will, at its sole option, repair or replace any components that fail in normal use. Such repairs or replacement will be made at no charge to the customer for parts and labor, provided that the customer shall be responsible for transportation costs. This warranty does not apply to the following:

- Cosmetic damage, such as scratches, cracks, nicks and dents
- Damaged resulting from an impact or fall
- Damage to the OBD II cable such as cuts, slices, or crushed areas.
- Damage caused by accident, misuse, abuse, water, flood, fire or acts of nature
- Damage resulting from exceeding the temperature limits of -20F to 160F. Do not leave UltraGauge unattended and exposed to extreme dash temperatures on hot days. Remove UltraGauge from the dash when leaving the vehicle or use a sunshade protector.
- Damaged caused by attempted service by an unauthorized person
- Damaged caused by disassembly
- Damaged caused by modifications
- Damage caused by attachment to a vehicle not OBD-II compliant
- Damage from reverse polarity battery, battery charger, jumper cables, etc.
- Damage to the windshield mount caused by forcing the locking arm
- Damage to the windshield mounting bracket or UltraGauge caused by attempting to adjust the windshield mount's flexible neck by grasping UltraGauge or the mounting bracket, rather than the neck itself
- Damage to the windshield mount bracket or Ultragauge as a result of using the optional locking ring. The optional locking ring supplied with the windshield mount should normally not be used and is only for the very rare case that the ball swivel is not tight enough to hold the position of UltraGauge. Use of the ring will result in increased force necessary to adjust the position of UltraGauge and if improperly used may result in damage. If used, it should be adjusted so that the balls swivel offers a very slight resistance to movement.

This product is intended as a supplement to existing vehicle gauges and should not be used in a capacity for which it was not intended. Ultra-Gauge.com makes no warranty to the accuracy of gauges.

Repairs have a 90-day warranty. The resulting warranty is either the remainder of the original limited 1-year warranty or 90-days, whichever is greater.

Ultra-Gauge.com retains the right to repair or replace, with a new or refurbished product, or offer a full refund.

To request warranty service, please create a support ticket here: http://ultra-gauge.com/customer_support

UltraGauge™ Table of Contents

WARNINGS.....	2
INSTALLATION WARNINGS.....	2
OPERATION WARNINGS.....	2
Liability.....	2
Battery Warning.....	2
Fuse Warning.....	2
NOTICES.....	3
Windshield Mounting Legal Notice.....	3
FCC Compliance.....	3
Rights and Obligations.....	3
Limited Warranty.....	3
Box Contents.....	8
UltraGauge™ EM Features.....	8
Installation.....	9
Detailed Installation instructions.....	9
<i>Velcro</i>	9
<i>Windshield Mount</i>	10
<i>Start-up & Configuration</i>	12
<i>Other Setup Considerations</i>	13
OPERATION.....	17
INDICATORS.....	17
HEALTH INDICATOR.....	17
LOOP INDICATOR.....	17
Light Sensor.....	17
CONTROLS.....	17
GAUGE PAGES & ZONES.....	18
PAGES.....	18
PAGES.....	19
GAUGE ZONE ASSIGNMENT.....	19
GAUGES.....	20
% Engine Load.....	21
Engine Coolant Temperature.....	21
Fuel Trim.....	21
Fuel Pressure.....	22
Intake Pressure (MAP).....	22
RPM.....	22
MPH / KPH.....	22
Ignition Timing Advance.....	22
Intake Air Temperature.....	22
Mass Airflow 1.....	22
Throttle Position.....	22
O ² Sensor Output Voltage.....	23
Distance with Check Engine Light on.....	23
Fuel Pressure (Diesel).....	23
Wide O ² Sensor Output lamda.....	23
EGR Commanded.....	23
EGR Error.....	24
Evaporative Purge %.....	24

Fuel Level %.....	24
Warm-ups Since Trouble Codes Cleared.....	24
Distance Since Trouble Codes Cleared.....	24
Evaporative Vapor Pressure.....	24
Barometric Pressure.....	24
Catalytic Converter Temperature.....	24
Battery Voltage.....	25
Load absolute %.....	25
AFR Commanded ratio.....	25
Relative Throttle Position %.....	25
Ambient Air Temperature.....	25
Accelerator Pedal Position.....	25
Throttle Position Commanded.....	25
Mass Air Flow 2.....	26
Instantaneous MPG,.....	26
KPL,.....	26
L/100k.....	26
Average MPG.....	26
Average KPL.....	26
Average L/100k.....	26
Average MPH.....	26
Average KPH.....	26
Distance.....	26
TRIP GAUGES.....	27
Short TRIP GAUGES.....	27
Boost Pressure.....	28
Horsepower 1 Kilowatts 1.....	28
Torque 1.....	28
Horsepower 2 Kilowatts 2.....	28
Torque 2.....	28
Fuel Level.....	29
RUN TIME (General).....	29
Instantaneous Gallons/Hour Liters/Hour.....	29
Distance To Empty (DTE).....	30
Time To Empty (TTE).....	30
Volumetric Efficiency % (MAP vehicles only).....	31
UltraGauge Temperature.....	31
<i>Gauge/Page Menu ..</i>	32
Select Gauges.....	32
Unassign All Gauges.....	32
Load Default Gauges.....	32
<i>Page Settings ..</i>	33
Page Display Format.....	33
Page Enables.....	33
Page Refresh Time.....	33
Auto Page Advance.....	33
Auto Page Time.....	33
<i>FUEL MENU ..</i>	34
Partial Tank fill up.....	34
Empty Fuel Tank.....	34

Fuel fill up.....	34
Level Sender Mode.....	34
<i>Disabled</i>	34
<i>Enabled</i>	34
<i>Smart</i>	35
Smart Full Threshold.....	35
Smart Low Threshold.....	36
Estimate Fuel Level.....	36
<i>Vehicle Setup</i>	37
SET ENGINE SIZE.....	37
SET FUEL TANK SIZE.....	37
Calibration.....	37
<i>Calibrate MPG/Fuel</i>	37
<i>Reset MPG/Fuel Cal</i>	38
<i>Calibrate Distance</i>	38
VE Enable (MAP only).....	39
VE RPM (MAP only).....	39
More.....	39
<i>Set HP1 Max Torque</i>	39
<i>Set HP2 Efficiency</i>	39
Force Protocol.....	40
<i>UltraGauge Setup</i>	41
Version.....	41
Save and Restart.....	41
Restore ALL Defaults.....	41
Factory Test.....	41
Compatibility ..	41
<i>Power on Detect mode</i>	41
<i>Power on Detect delay</i>	42
<i>Power off Detect mode</i>	42
<i>Power off retries</i>	42
<i>KWP/9141 Optimize</i>	43
<i>Force MPG Sensor</i>	43
Injector Cutoff.....	44
DISPLAY SETTINGS	45
SET Backlite Mode.....	45
<i>Fixed:</i>	45
<i>Automatic:</i>	45
Backlite Min Brightness.....	45
Backlite Max Brightness.....	46
Ambient Sensitivity.....	46
Adjust LCD Contrast.....	46
ALARMS	47
Set Gauge Alarms ..	47
Alarm siren on/off.....	47
All alarms on/off.....	47
Alarm siren freq.....	47
Load Default Alarms.....	48
Trouble Code Alarm.....	50
Pending TC Alarm.....	50

<i>Trouble Codes</i>	51
Clear Check Engine	51
Engine Trouble Codes.....	51
Pending Codes	51
<i>Miscellaneous</i>	52
Units of Measure.....	52
Using UltraGauge on more than one vehicle.....	52
Cleaning	52
Frequently Asked Questions.....	52
Troubleshooting.....	54
Specifications.....	55
Document Revision History.....	55
OBDII Compliancy decals.....	56

Box Contents

- UltraGauge & OBDII Cable
- UltraGauge protective plastic sleeve
- Windshield mount and optional locking ring (The ring can be used if the ball swivel is not tight enough)
- Windshield bracket – already attached to UltraGauge
- Two Velcro Squares. Taped to the inside bottom of the box. Used for optional mounting.
- Warning insert with link to Rebate/Website.

UltraGauge™ EM Features

- Supports most 1996 and newer OBDII compliant vehicles***
- Up to 76 selectable English Gauges*
- Up to 46 selectable Metric Gauges*
- Real time and long term mileage gauges
- Distance-To-Empty & Time-to-Empty Gauges
- Horsepower and torque gauges
- 7 pages of gauges for as many as 56 quickly accessible gauges
- Each gauge page can be individually configured to display 4, 6, or 8 gauges.
- Each gauge page can be enabled or disabled
- Auto-Page advance, cycles through gauge pages
- Each gauge can be assigned to any page and to multiple pages
- The rate at which gauges are updated is configurable
- Configurable low and high alarms for every gauge
- Audible and Visual Alarms
- Alarms may be individually suspended.
- Displays both current and pending trouble codes
- Clear Check Engine Light and Trouble Codes
- Current and pending Trouble Code Alarms
- Automatic fuel fill-up detection **
- Oil change and Service Gauges
- Trip and short trip Gauges
- Health indicator
- Internal Temperature sensor that can be monitored and alarmed
- Closed and open loop indicator.
- Large LCD Display
- Display Brightness adjusts automatically to ambient light
- Lightweight easy to route OBD II cable
- Compact and easily mounted with Velcro or windshield mount
- Low power
- Retains configuration and accumulated data across power cycles
- Automatically detects and turns off display when vehicle is off****
- Comprehensive menu system

* Actual number of gauges supported is vehicle dependent

** Auto Fill-up detection is not available on all vehicles.

*** Some vehicles may not be OBD-II compliant. Compliance is printed on the emission decal typically located in the engine compartment. See example compliance decals at the end of this document.

**** Display will remain on while in the menu system. Always exit the menu system when the ignition is in the OFF position.

Installation

The Basic installations steps are as follows:

1. Choose method of mounting; Velcro or windshield mount
2. Install the mount (The optional ring can be used if ball swivel is not tight enough)
3. Attach UltraGauge to the mount
4. Optionally coil extra cable near UltraGauge to allow UltraGauge to be disconnected from mount and conveniently configured
5. Route the remainder of the cable such that it is tucked away and does not interfere with vehicle controls, such as steering, wiper control, transmission shifter, turn signal, foot controls, and does not represent a hazard to vehicle entry or exit.
6. Connect the UltraGauge OBD II connector to the OBD II connector on the vehicle
7. Turn the ignition to the RUN position. (The ignition has four positions: OFF, ACC, RUN & START. You do not need to start the vehicle)
8. UltraGauge will then determine the vehicle's protocol and discover the available gauges.

Detailed Installation instructions

1. Choose method for mounting; Velcro or windshield mount. The Velcro mount has the advantage that it can be used to attach in areas less visible from outside the vehicle, reducing the risk of vandalism and theft. The Velcro mount is also less likely to loose attachment over time and is inherently less obstructive.
The windshield mount has the advantage that it typically positions UltraGauge in an area that is closer to the view of the road and hence potentially represents less interruption to driving concentration. The windshield mount can also be attached to any smooth surface and is therefore not limited to the windshield..

Velcro

The Velcro strip is comprised of two parts, a hook half and a loop half. Both the loop and hook halves use an adhesive face. Either face can be attached to UltraGauge. Adhere the Velcro to UltraGauge according to one of the two diagrams below.

NOTE: Make sure the windshield mount bracket has first been removed from UltraGauge

OPTION 1:

This is the preferred method providing the most resistant to rotation. Cut one of the Velcro strips in half. Remove the protective wax paper from one side of the Velcro. Press Velcro adhesive face firmly against UltraGauge, as shown. Avoid blocking the vent holes.

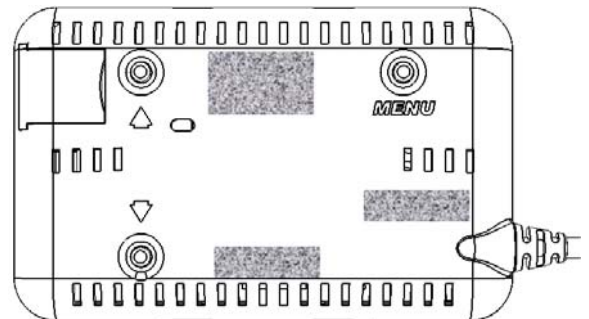

OPTION 2:

Remove the protective wax paper from one side of the each Velcro Piece. Press each Velcro adhesive face firmly against UltraGauge at the positions shown. Care should be taken to avoid blocking the vent holes.

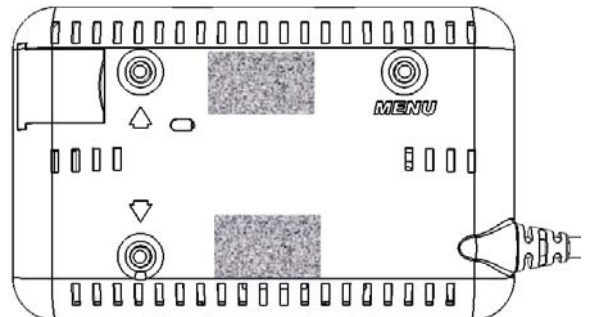

Ensure that the surface to which UltraGauge shall be attached is flat, smooth, clean and dry. Once the Velcro has been firmly attached to the back face of UltraGauge, remove the remaining protective wax paper from the Velcro. Press UltraGauge firmly against the desired mounting surface. UltraGauge is now mounted and can be removed and attached repeatedly to configure as necessary.

It is also possible to place slugs or washer behind the UP, DOWN and MENU keys such that pressing the front of UltraGauge depresses the switches, thus effectively converting the switches to the front.

Windshield Mount

Before selecting a mounting position, check state and local laws and ordinances to determine permissible mounting locations. Generally the preferred and optimal location is the left lower corner of the windshield, as this location is the least obstructive, generally closest to the OBD-II connector of the vehicle, semi-shaded, and is least visible from outside the vehicle. This location also will not block the use of a windshield sun-shade.

WARNING: Do not leave UltraGauge unattended and exposed to extreme dash temperatures on hot days. Damage to the LCD can occur. Remove UltraGauge from the dash when leaving the vehicle or use a sunshade protector.

Optional locking Ring: The ring can be used if ball swivel is not tight enough. See the Warranty and Installation warnings. If used, it should only be installed with minimal tightness.

1. Before attaching the mount to the windshield, mold the neck of the windshield mount as necessary to the slope of your windshield and for the desired position of UltraGauge.



Never attempt to mold the neck of the windshield mount by grasping the mounting bracket or UltraGauge. Damage to UltraGauge and/or the mounting bracket may occur, as the neck while flexible is relatively rigid.

- Clean the windshield mounting area. This is crucial as any grease, dust, dirt or moisture will ultimately cause the attachment to fail. Make sure the surface is completely dry before proceeding.

- Make sure the Windshield Mount locking arm is fully released. Do not force the arm. There are two release tabs as shown. Grip the release tabs with your thumb and index finger, and pull the release tabs in the direction of the arrows imprinted on the release arm. This will release the locking arm.



- Once released, move the locking arm towards the Windshield Mount's neck, as shown, to release the suction cup.



- With the Windshield Mount's release arm fully released, press the silicon base firmly against the windshield, and press the Windshield mount's locking arm. It will "click" as it is pressed.

When it has reached the end of its travel it will become resistant to further movement. Do not attempt to force the locking arm as only a few "clicks" are necessary and excess force may damage the mount. The windshield mount should now be firmly attached to the windshield. If not, it is likely caused by the silicon base not being placed fully flat against the windshield. Release the locking arm as described above and repeat.



- Attach the mounting bracket adapter to UltraGauge such that the bracket's release arm is at the top as shown in this diagram.

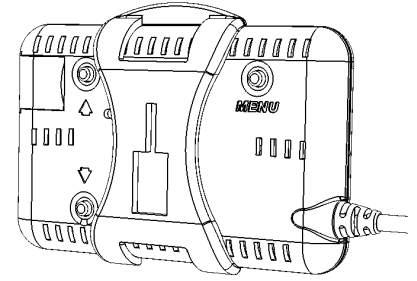

- Attach the UltraGauge/Bracket assembly to the windshield mount by aligning the large rectangular opening of the bracket with the matching rectangular structure on the windshield mount. Slide down to attach. Note that it may be necessary to rotate the windshield mount's head 180 degrees.
- The windshield mount also includes a locking ring which can be optionally added to the swivel ball mount to lock it in place. In most cases the swivel ball mount is sufficiently rigid.

2. Remove and save the twist tie from the cable. Now that UltraGauge is mounted, form an 8" diameter loop with the OBD-II cable near UltraGauge. This loop will allow UltraGauge to be removed from the mount and configured rather than attempting to configure UltraGauge while it is held in the mount.



3. Locate the vehicle's OBD-II connector. This connector is typically found above the foot controls and below the steering column. See the diagram below. In rare cases, the connector may be found in a similar location on the passenger side or even in the vehicle's console. To determine where the OBD-II connector is located for your vehicle, please use the following resource: <http://obdclearinghouse.com/index.php?body=oemdb> If your vehicle is not listed, check other like model years.

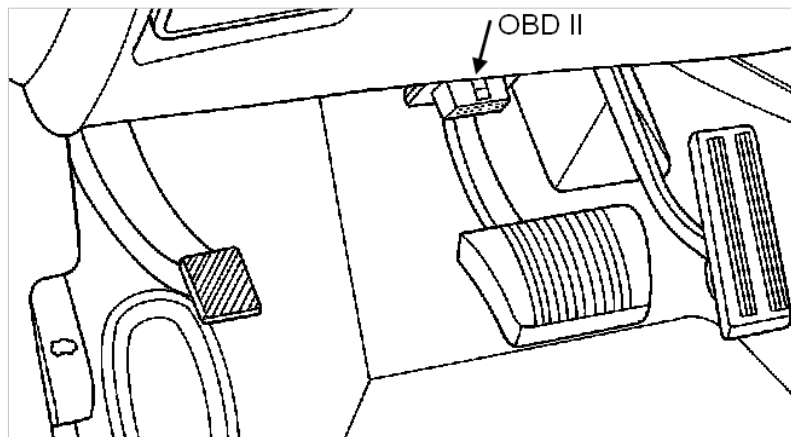
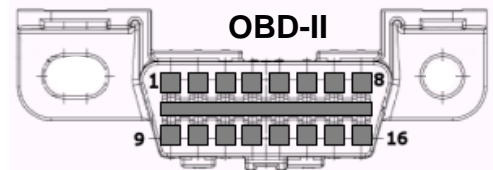

4. Once the OBD-II connector is located, route the OBD-II cable so that it does not block or interfere with foot controls. The UltraGauge connector is a right-angle connector. This design limits the connector from protruding into the foot controls area. Tuck the cable into gaps between the dash and surrounding structures. Route the cable under the dash such that it will not hang down into the foot control area. Care should be taken not to route the cable near moving objects, such as the hood release, emergency brake, brake release, foot controls and associated mechanisms. If appropriate, use the twist tie to secure any excess cable.
5. Set the ignition to the RUN position, and plug the cable into the vehicle's OBD-II connector.

Start-up & Configuration

When UltraGauge is first attached to the vehicle's OBD-II connector it is immediately powered, as the vehicle's OBD-II connector is always powered. Once connected UltraGauge will begin scanning the interface to determine the vehicle's protocol. **The vehicles ignition must be in the RUN position** in order for UltraGauge to communicate with the vehicle's Electronic Control Module (ECM). The ignition must remain in the RUN position during both scanning and gauge discover.

The scanning process typically completes in 1 to 6 seconds. As UltraGauge scans it continues to print asterisks to the screen. If after 12 seconds UltraGauge has not found the protocol in use, it is likely that the ignition is not in the RUN position. If UltraGauge fails to detect the vehicle's computer and protocol, UltraGauge will enter a low power mode after 2 minutes. In this mode the Backlight is turned off. UltraGauge will stay in this mode until either the UP or DOWN key is pressed.

When UltraGauge successfully determines the vehicle's protocol, it replaces "SCANNING" with the identified protocol. The possible Protocols are:

Protocol	Manufacturer
J1850 VPM	GM & Chrysler
FORD	Early Ford
9141	Chrysler & Foreign
KWP 2000	Rare, various
11-bit CAN	Most 2008 and newer
29-bit CAN	Most 2008 & newer Honda, Volvo

Once the protocol is identified, UltraGauge will remember the protocol and should UltraGauge become unplugged, it will try this protocol first. UltraGauge will then begin the process of discovering the gauges supported by the vehicle. Again, **the ignition must remain in the RUN position during discovery**, otherwise UltraGauge will print "Comm Lost, restarting". Once complete, the number of discovered gauges and the total including metric gauges is briefly displayed at the bottom of the screen. If "Comm Lost, restarting" persists, please see the *Enhanced and Safe mode Gauge Discovery* section.

If UltraGauge has yet to be configured, you will be prompted for your vehicle's engine and fuel tank size. Use the UP/DOWN keys to set the engine and tank size. Press MENU to store each value.

Once the engine and tank size are entered, a warning screen is presented.

** WARNING **
 Never use the Menu
 while operating
 the vehicle
 Injury or Death
 may occur

Press enter to continue

UltraGauge is now up and running

Pressing **DOWN**, advances the screen to the next page of gauges.

By default, several gauges are preselected. Alternate gauges can be selected via the menu system. The available gauges are described in the GAUGES section.

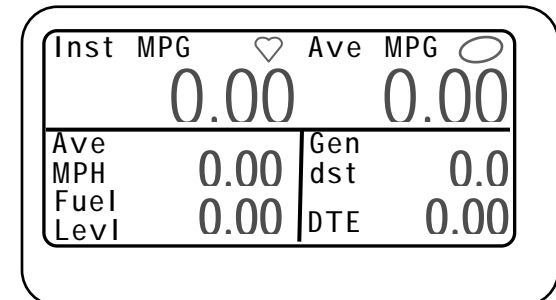
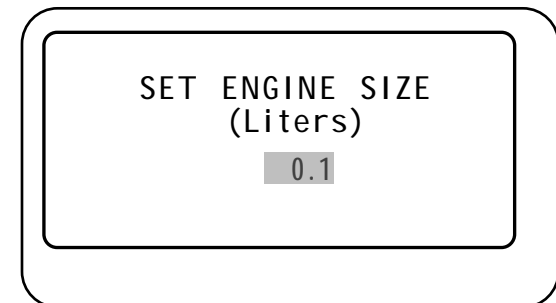
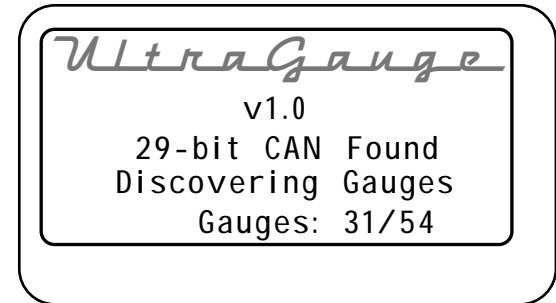
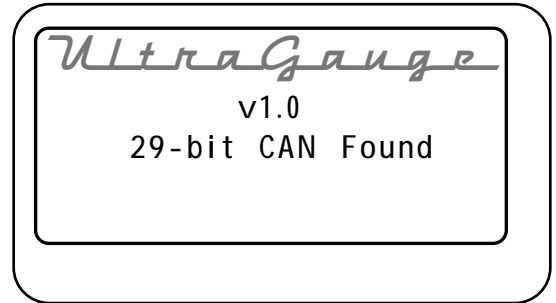
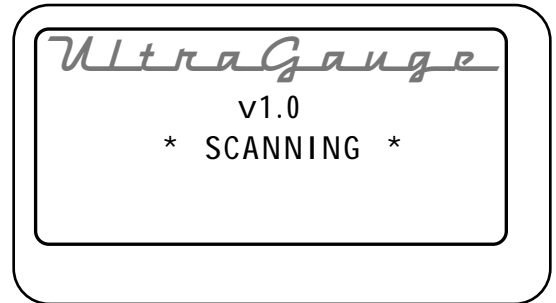

Other Setup Considerations

UltraGauge is pre-configured for the most compatible configuration. However, there are various implementations of the OBDII standard that may require special configuration. The following suggests configuration settings that may be necessary depending upon your vehicle as well as other configuration setting you should be aware of.

Ignition on Detection

There are two “ignition on” detection modes. When the ignition is switched to OFF, UltraGauge enters a low power mode where the display is powered off. When the ignition is switched from OFF to RUN, UltraGauge will detect this in 1-6 seconds and power back on. If UltraGauge fails to power back on, please see the [Compatibility ..](#)

[Power on Detect mode](#) in the “UltraGauge setup..” section.

Ignition off Detection

If after the vehicle’s ignition switch is set to OFF, UltraGauge remains on, please see the [Power off Detect mode](#) in the “UltraGauge setup..” section.

Mileage Gauges

During the scanning and gauge discovery process, UltraGauge determines the most accurate means to calculate fuel usage based upon the various sensors available in the vehicle. Normally no intervention or configuration is necessary. However, in rare cases, some vehicles may mis-report the presence of a particular sensor which UltraGauge will then attempt to use to calculate the various mileage gauges, such as Instantaneous MPG, Average MPG, Gallons/Hour, etc. When this issue is present, many of the mileage gauges will display “Err”. Other gauges such as engine temperature, RPM, MPH, etc., will display correctly. This is common on many large Diesel Ford trucks. If seen, please see this section for more information:

Impaired or odd behavior of vehicle systems

If after installing UltraGauge your vehicle is experiencing odd behavior, such as various dash lights have become lit, factory gauges stop working, vehicle fails to shift, hard shifting, etc. Please see the following section:

[More ..](#)

Set HP1 Max Torque

MENU → *Vehicle Setup ..* → *More ..* → *Set HP1 Max Torque*

Sets the maximum engine torque for the target vehicle. This parameter must first be configured prior to using HP1, KW1 or Torque 1 gauges. The maximum torque is a common parameter that can be found by searching the internet for the engine specification for your vehicle. The torque is commonly specified as a Torque @ a particular RPM. For example, 200 ft.lbs @ 3200 RPM. The torque may be entered in Foot-Pounds (ft.lbs) or Newton Meters (Nm).

Set HP2 Efficiency

MENU → *Vehicle Setup ..* → *More ..* → *Set HP2 Efficiency*

Sets the estimated operating efficiency of the engine. This parameter can be set before using the HP2, KW2 or Torque2 gauges. Horsepower 2, Kilowatts 2 and Torque 2 are derived based on the amount of energy being consumed by the engine and the engine’s efficiency. By default the efficiency is assumed to be 24%. This means that only 24% of the energy contained in the fuel actually produces power or torque output. 24% is a good average for typical modern vehicles. This value can be adjusted if more specific information is available.

Force Protocol

MPG Accuracy

For best results, UltraGauge should be calibrated for both distance measurements and fuel measurement. See the following section: Calibration. Vehicles which use a Manifold Absolute Pressure (MAP) sensor instead of a Mass Air Flow (MAF) sensor should also see the following section:

VE Enable (MAP only) and VE RPM (MAP only).

To determine which sensor your vehicle uses see this section: Version

Alarms

Certain Alarms come pre-enabled while others are disabled. Please see these sections for customizing alarms: ALARMS.. and Trouble Code Alarm.

KWP/9141 Optimization

The rate at which the display updates for vehicles with the KWP2000 or 9141 protocol may be slower than desired. There is a configuration setting which may allow the rate to be increased. See the following setting:

Enhanced and Safe mode Gauge Discovery

When UltraGauge is connected to the OBDII connector it begins scanning for the protocol supported. Once found UltraGauge then discovers the available gauges. There are two discovery modes; Enhanced & Safe. By default Enhanced is selected and recommended. If during the discovery process, with the ignition in the RUN position, the message “Comm lost, Restarting” is displayed, then press DOWN when prompted to enter Safe mode. UltraGauge will remember the mode selected. Once in Safe mode, the prompt will change and pressing DOWN will return to Enhanced mode.

Injector Cutoff Detection

During de-acceleration, many vehicle manufacturers will turn off the fuel injectors to save fuel. UltraGauge can detect this and factor it into the fuel usage calculations. Depending on your driving conditions, this may or may not have a significant affect on mileage results. By default this feature is disabled. See the Injector Cutoff section for more information.

OPERATION

Once operating, UltraGauge is automatic. NEVER use the menu system while driving. Not only is this hazardous, UltraGauge stops performing all mileage, distance, and other calculations while the menu system is active. Always ensure the engine is not running, but the ignition is in the RUN position, before using the menu system. Normally UltraGauge detects and automatically turns off the display when the ignition is in the OFF position. However, this feature is not active while using the menu system. Always exit the menu when the ignition is off otherwise the display and backlight will remain on, and may drain the battery if left in this state for many days.

INDICATORS

While configured to display 4 or 6 gauges per page, two indicators are displayed.

HEALTH INDICATOR

The Health indicator is a heart that beats roughly every second. As long as the heart continues to beat, UltraGauge is functioning normally.

LOOP INDICATOR

The Open/Closed loop indicator provides a visual indication of the state of the vehicle's fuel mixture control system. Closed loop is the desired and nominal condition, and indicates that the vehicle's Engine Control Module (ECM) is using the vehicle's Oxygen and other sensors to set the real time fuel mixture.

An open loop will normally occur when the vehicle is cold, or when the throttle is wide open, or when the engine is being used to decelerate the vehicle. If the loop remains open this indicates that there is a problem with the overall fuel mixture system and the ECM is no longer able to determine the correct fuel mixture. In this situation the ECM uses a static table to approximate the fuel mixture. In this state the fuel mixture will likely be too rich or too lean. Continued open loop operation will likely result in a Trouble code. This indicator is not present on most Diesels.

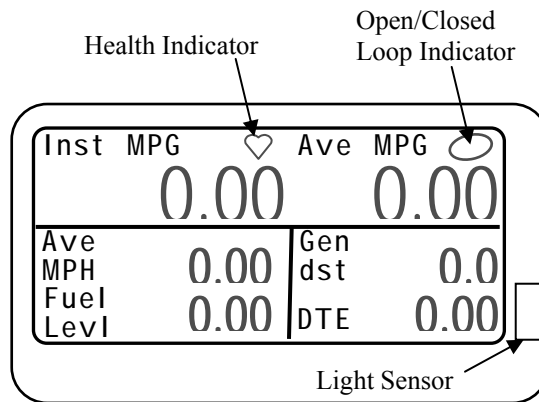

Light Sensor

UltraGauge features a light sensor that is used to optionally automatically adjust the brightness of the display. During the day, the display backlight will automatically adjust to maximum brightness, and to minimum brightness for night driving. It is important that the light sensor window is not blocked as a result of installation. The Light Sensor Port is located on the front right side of UltraGauge, as shown above. The backlighting function is fully configurable. See the Backlighting section for additional details.

CONTROLS

There are three controls used to setup, configure and control UltraGauge. The controls consist of the following three input keys which are located on the back of UltraGauge.

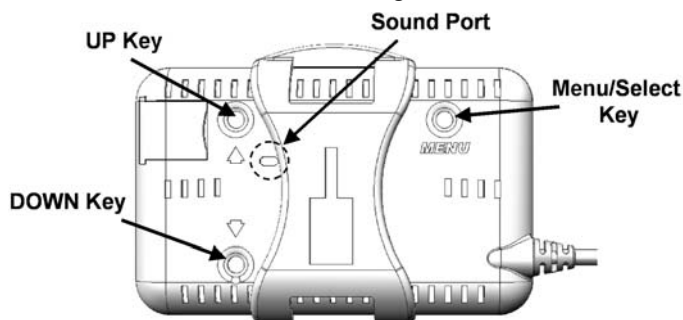

KEY	Function in Menu	Alternate Function
MENU SELECT	Used to enter the Menu. It is also used to indicate a selection.	None
UP	Moves the cursor upward or increases the value of an entry.	From the main gauge screen, pressing and holding UP for three seconds triggers a Tank Fill Up. When in low-power mode, pressing UP, exits low power mode.
DOWN	Moves the cursor downward or decreases the value of an entry.	Two Alternate functions: From the main gauge screen, pressing DOWN will advance to the next page of gauges. During an Alarm, pressing Down will suspend the alarm.

To make configuration changes, hold UltraGauge with the display towards you and manipulate the keys from behind using two hands. Once you get the hang of it, it will be obvious.

When entering values, holding the UP or DOWN key pressed will cause the value to advance faster.

The Sound port is used to provide audible tones while accessing the menu system and for alarms.

GAUGE PAGES & ZONES

UltraGauge can display seven separate pages of gauges. Each page can independently be configured to display 4, 6 or 8 gauges. Gauges are displayed by assigning a gauge to a particular zone. Zones are identified by a number 1 through 8. Assigning a gauge to zone “1”, places the Gauge in the upper left hand corner, as shown below. Likewise, a gauge assigned to Zone “6”, places the gauge in the lower right hand corner. Zones that are unused on a page are ignored, but still may be assigned should you wish to switch between 4, 6 or 8 gauges per page.

During normal operation, to advance to the next page of gauges press and hold the **DOWN** arrow key for 1 second. UltraGauge will emit a tone when the page advance is recognized. Pressing **DOWN** on the last enabled page returns the display to page 1.

Gauge Zone Ordering

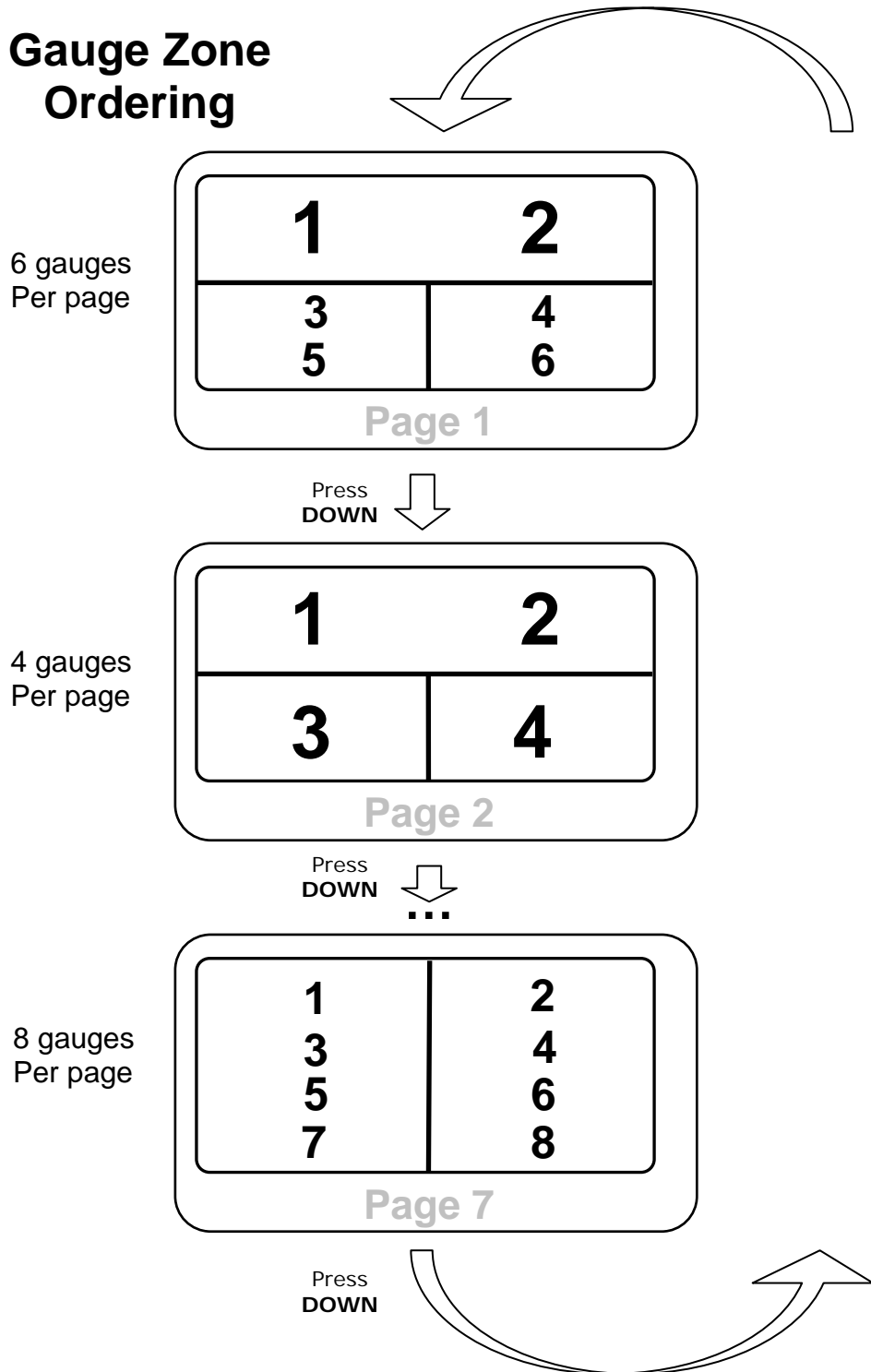

PAGES

Each of the seven pages can individually be enabled or disabled.

MENU → Gauge/Page Menu .. → Select Gauge/Page .. → Page settings .. → Page Enables

A disabled page will be skipped when the page is manually or auto advanced.

Each page can be configured to display 4, 6 or 8 Gauges.

MENU → Gauge/Page Menu .. → Select Gauge/Page .. → Page settings .. → Page Display Format

Any gauge can be assigned to any zone on any page. A gauge can be assigned to one or all pages. For example, RPM could be assigned to zone 1 on all seven pages. A gauge can only be assigned once on any given page.

If enabled, the auto page advance feature will cycle through each enabled page.

MENU → Gauge/Page Menu .. → Select Gauge/Page .. → Page settings .. → Auto Page Advance

The duration that a given page is displayed is configurable from 1-255 seconds. Each page can have a unique duration if desired.

MENU → Gauge/Page Menu .. → Select Gauge/Page .. → Page settings .. → Auto Page Time

The Rate at which gauges are updated is configurable from 0.3 seconds to 2 seconds.

MENU → Gauge/Page Menu .. → Select Gauge/Page .. → Page settings .. → Page Refresh Time

The set Refresh time applies to every page. This setting also affects the rate at which the Heart Beat indicator beats. Lowering the refresh time, increases the heart beat rate and the rate at which gauges are updated. This setting is intended for vehicles with the CAN protocol and is not recommended for KWP and 9141 protocols.

GAUGE ZONE ASSIGNMENT

To assign a gauge to a page and zone:

1. select **MENU → Gauge/Page Menu .. → Select Gauge/Page .. → Select Gauges → Select Page n Gauges**
2. Use the **UP & DOWN** keys to Navigate to the desired Gauge. Press **Next** or **Back** to advance to the next group of gauges
3. While the cursor is positioned next to the desired gauge, Press **MENU**. This will cause the cursor to blink.
4. Pressing **UP** or **DOWN** will cause the Cursor to change to a number corresponding to Zones 1-8. You may also continue to hold **UP** or **DOWN** and the zones will advance automatically.
5. When the desired Zone is displayed, Press **MENU** to assign the Gauge to that Zone. Once assigned the cursor will stop blinking.
6. Repeat the operation for each desired Gauge.

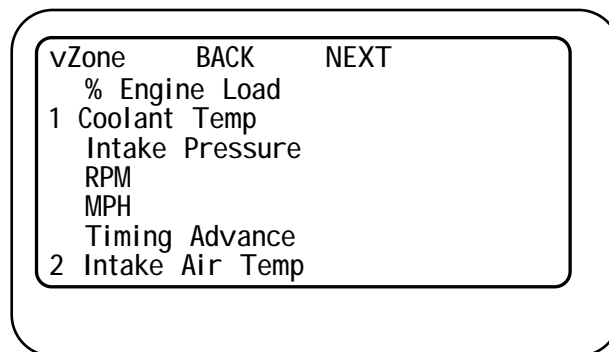

Once a gauge has been assigned to a zone, it is saved. The UltraGauge configuration is stored in non-volatile memory so that it is preserved through car start/stop cycles or when the unit is unplugged. The configuration remains until changed.

All the gauges can be unassigned, with the menu item:

MENU → Gauge/Page Menu .. → Select Gauge/Page .. → Unassign All Gauges.

Once unassigned the Main Gauge screen will show no gauges, and will only show the loop indicator and heartbeat and the text: “No Gauges Selected”. This will be true for each gauge page set to display 4 or 6 gauges. This will also be true on a gauge page basis if all the zones of a page are unassigned manually as part of the gauge zone assignment process.

GAUGES

The total potential available gauges is summarized in Table 1 - Potential Available Gauges. The actual gauges available is always vehicle dependent. Once the initial gauge discovery process is complete, the number of available gauges and the number including metric will be displayed; Gauges/Metric. To determine which specific gauges are available, select:

MENU → Gauge/Page Menu .. → Select Gauges.. → Select Page n Gauges

In general vehicle manufacturers are federally required to report gauges that are specifically used in the determination of the fuel mixture for emissions purposes. Typically older vehicles provide a minimum of gauges while many newer vehicles support nearly all gauges.

Table 1 - Potential Available Gauges

English Gauge	Metric Gauge	English Gauge	Metric Gauge
% Engine Load		Boost Pressure, Relative Pressure (PSI)	Boost Pressure, Relative Pressure (kPa)
Engine Coolant Temperature (°F)	Engine Coolant Temperature (°C)	Brake Horsepower 1	Brake Kilowatts 1
Short Term Fuel Trim Bank 1		Torque 1 (ft lbs)	Torque 1 (N.m)
Long Term Fuel Trim Bank 1		Brake Horsepower 2	Brake Kilowatts 2
Short Term Fuel Trim Bank 2		Torque 2 (ft lbs)	Torque 2 (N.m)
Long Term Fuel Trim Bank 2		Mass Air Flow Sensor 2 – Calculated	
Fuel Pressure (PSI)	Fuel Pressure (kPa)	Instantaneous MPG	Instantaneous KPL
Intake Manifold Absolute Pressure(MAP) (PSI)	Intake Manifold Absolute Pressure(MAP) (kPa)	Average MPG – General	Instantaneous L/100Km
RPM		Average MPH – General	Average KPL – General
MPH	KPH	Average G/H - General	Average L/100Km – General
Timing Advance		Run Time – General	Average KPH – General
Intake Air Temperature (°F)	Intake Air Temperature (°C)	Miles – General	Average L/H - General
Mass Air Flow Sensor 1 (g/s)		Gallons Used – General	Kilometers – General
Absolute Throttle Position 1 %		Instantaneous Gallons/Hour	Liters Used – General
Bank 1 Oxygen Sensor 1 Voltage		Miles to Empty	Instantaneous Liters/Hour
Bank 1 Oxygen Sensor 2 Voltage		Fuel Level (gallons)	Kilometers to Empty
Bank 2 Oxygen Sensor 1 Voltage		Time to Empty(TTE) (Hours:Mins)	Fuel Level (Liters)
Bank 2 Oxygen Sensor 2 Voltage		Volumetric Efficiency (MAP vehicles only)	
Miles traveled with Check Engine Light On.	Kilometers traveled with Check Engine Light On.	Average MPH – Trip	Average KPH – Trip
Fuel Pressure (Diesel) (PSI)	Fuel Pressure (Diesel) (10kPa)	Average MPG – Trip	Average KPL – Trip
Bank 1 Wide Oxygen Sensor 1 Lambda		Gallons Used – Trip	Average L/100Km - Trip
Bank 2 Wide Oxygen Sensor 1 Lambda		Average Gallons/Hour – trip	Liters Used - trip
EGR Flow %		Run Time – Trip (Hours:Minutes)	Average Liters/Hour – trip
EGR Flow % Error		Miles –Trip	Kilometers - Trip
Evaporative Purge %			
Fuel Level % of full			
Number of Warm-ups since Check Engine Light Cleared			
Miles traveled since Check Engine Light Cleared	Kilometers traveled since Check Engine Light Cleared	Average MPH – Short Trip	Average KPH – Short Trip
Evaporative Vapor Pressure (PSI)	Evaporative Vapor Pressure (Pa)	Average MPG – Short Trip	Average KPL – Short Trip
Barometric Pressure – Inches of Mercury (inHg)	Barometric Pressure – Inches of Mercury (kPa)	Gallons Used – Short Trip	Average L/100Km - Short Trip
Catalytic Converter Bank 1 Sensor 1 Temperature (°F)	Catalytic Converter Bank 1 Sensor 1 Temperature (°C)	Average Gallons/Hour – Short Trip	Liters Used - Short Trip
Catalytic Converter Bank 2 Sensor 1 Temperature (°F)	Catalytic Converter Bank 2 Sensor 1 Temperature (°C)	Run Time – Srt Trip (Hours:Minutes)	Average Liters/Hour – Short Trip
Catalytic Converter Bank 1 Sensor 2 Temperature (°F)	Catalytic Converter Bank 1 Sensor 2 Temperature (°C)	Miles – Short Trip	Kilometers - Short Trip
Catalytic Converter Bank 2 Sensor 2 Temperature (°F)	Catalytic Converter Bank 2 Sensor 2 Temperature (°C)		
Battery Voltage		Oil Change Distance (miles)	Oil Change Distance (Km)
Load absolute %		Service Distance (miles)	Service Distance (Km)
AFR Commanded Ratio		UltraGauge Internal Temperature (°F)	UltraGauge Internal Temperature (°C)
Relative Throttle Position %			
Outside Ambient Air Temperature (°F)	Outside Ambient Air Temperature (°C)		
Absolute Throttle Position 2 %			
Accelerator Pedal Position 1 %			
Accelerator Pedal Position 2 %			
Command Throttle Position %			

Gauges in Blue are new for UltraGauge EM

% Engine Load

Gauge name	Range	Units	Abbreviation
% Engine Load	0 to 100	%	%Eng load

Estimated percent of engine load. Where engine load is calculated as

$$\% \text{ Load} = \frac{\text{Current Air flow}}{\text{Peak Air Flow}}$$

Or

$$\% \text{ Load} = \frac{\text{Current Engine Torque}}{\text{Peak Engine Torque}}$$

The method used is vehicle dependent.

Engine Coolant Temperature

Gauge name	Range	Units	Abbreviation
Coolant Temp °F	-40.0 to 419.9	°F	Eng °F
Coolant Temp °C	-40.0 to 215	°C	Eng °C

Derived directly from the engine coolant temperature sensor or a cylinder head temperature sensor. Diesels may report engine oil temperature instead.

Fuel Trim

Gauge name	Range	Units	Abbreviation
Shrt fuel trim bank 1	-100% to 99.2%	Percent of typical	Srt tr1
Long fuel trim bank 1			Lng tr1
Shrt fuel trim bank 2			Srt tr2
Long fuel trim bank 2			Lng tr2

Fuel trim refers to the fine tune control of fuel delivery and specifically indicates adjustments made dynamically to the base fuel table to obtain the proper ratio of fuel to air. The fuel-to-air ratio is adjusted by increasing or decreasing the time fuel injectors are open. Note that fuel injectors are either fully open or fully closed - there is no variable opening.

Fuel trim is generally calculated by using a wide set of data values, including forward O² sensors, intake air temperature/pressure or air mass sensor, barometric pressure, humidity, engine coolant temp, anti-knock sensors, engine load, throttle position, and battery voltage.

Short term fuel trim refers to adjustments being made in response to temporary short term conditions.

Long term fuel trim is used to compensate for issues that seem to be present over a much longer period or that are essentially permanent. Long term fuel trim generally should not exceed +/- 10% in most vehicles.

Fuel trims are expressed in percentages with a range of -100% to 99.2% of nominal. Positive values indicate a lean condition exists and the injector is left open longer to compensate, thus adding more fuel. Negative values indicate a rich condition exists and the injectors are closed more quickly thus reducing the amount of fuel.

Example: A value of 5.0% indicates that the injector is being left open 5% longer than normal, thus the fuel to air ratio is being increased.

Fuel trim could more appropriately be called "Injection on-time %".

Fuel trim banks refer to the cylinder banks in a V style engine. Cylinder #1 is always in bank 1. Even though the engine may contain two physical banks, only a single bank may be reported by the ECM. UltraGauge displays Fuel Trim Banks One and Two if reported by the vehicle's engine computer. For those vehicles with three or four banks, only banks one and two will be available for display on UltraGauge.

UltraGauge supports the following Fuel Trim Gauges:

- Short Term Fuel Trim percentage Bank 1
- Short Term Fuel Trim percentage Bank 2
- Long Term Fuel Trim percentage Bank 1
- Long Term Fuel Trim percentage Bank 2

NOTE: If the engine is operating in Open Loop, the short trim will be reported as 0%.

Fuel Pressure

Gauge name	Range	Units	Abbreviation
Fuel Pressure PSI	0 to 111	PSI	Fuel PSI
Fuel Pressure kPa	0 to 765	kPa	Fuel kPa

Fuel rail pressure at the engine relative to atmosphere (Gauge pressure)

Intake Pressure (MAP)

Gauge name	Range	Units	Abbreviation
Intake Pres abs PSI	0 to 36.98	PSI	MAP PSI
Intake Pres abs kPa	0 to 255	kPa	MAP kPa

Intake Manifold Absolute Pressure (MAP). This is absolute pressure as opposed to being relative to atmosphere (gauge pressure).

The pressure reported is the pressure above absolute vacuum. When this gauge reports 14.7 PSI, that means the pressure in the manifold is the same as that of outside air (at sea level).

RPM

Gauge name	Range	Units	Abbreviation
RPM	0 to 16,384	RPM	RPM

Rotations per minute of the engine crankshaft

MPH / KPH

Gauge name	Range	Units	Abbreviation
MPH	0 to 158.4	MPH	MPH
KPH	0 to 255	KPH	KPH

Vehicle road speed

Ignition Timing Advance

Gauge name	Range	Units	Abbreviation
Timing Advance	-64 to 63.5	degrees	Tmg Adv

Ignition timing spark advance in degrees before top dead center for cylinder #1. Does not include mechanical advance, if any.

Intake Air Temperature

Gauge name	Range	Units	Abbreviation
Intake Air Temp °F	-40.0 to 419.9	°F	Intk °F
Intake Air Temp °C	-40.0 to 215	°C	Intk °C

The temperature of the air in the intake manifold. When the engine is cold, this is equivalent to outside air temperature

Mass Airflow 1

Gauge name	Range	Units	Abbreviation
Mass Air Flow 1 g/s	0 to 655.35	grams/second	MA1 g/s

The Mass Airflow rate of air into the intake manifold. This is the raw un-calibrated sensor output. The sister gauge, "Mass Airflow 2" is the calibrated or calculated version

Throttle Position

Gauge name	Range	Units	Abbreviation
Throttle Position 1 %	0 to 100	%	abs TP1%
Throttle Position 2 %			abs TP2%

The percentage that the throttle is open. This is the absolute output from the throttle position sensor as a percent of the TP Sensor's max value. The closed and wide open throttle positions will likely not be equal to 0% and 100% respectively. For example, the physically closed throttle position may correspond to an absolute position of 8%.

"Throttle Position 2" is for vehicles with a second throttle Position Sensor

O² Sensor Output Voltage

Gauge name	Range	Units	Abbreviation
Bank1 O ² Sensor 1 Voltage	0 to 1.275	Volts	Bnk1 O2 1
Bank1 O ² Sensor 2 Voltage			Bnk1 O2 2
Bank1 O ² Sensor 3 Voltage			Bnk1 O2 3
Bank1 O ² Sensor 4 Voltage			Bnk1 O2 4
Bank2 O ² Sensor 1 Voltage			Bnk2 O2 1
Bank2 O ² Sensor 2 Voltage			Bnk2 O2 2
Bank2 O ² Sensor 3 Voltage			Bnk2 O2 3
Bank2 O ² Sensor 4 Voltage			Bnk2 O2 4

Raw output from the O₂ sensor. 0 volts is equivalent of 100% lean fuel air mixture and 1.275 volts is 99.2% rich fuel air mixture. Bank1 is the cylinder bank with spark plug #1. Typically only two O₂ sensors are present, one on each bank.

Distance with Check Engine Light on

Gauge name	Range	Units	Abbreviation
Miles with CEL on	0 to 40,722	miles	mi CEL
Kilometers w/CEL on	0 to 40,722	kilometers	km CEL

Distance traveled since the Check Engine Light (CEL) illuminated.

Fuel Pressure (Diesel)

Gauge name	Range	Units	Abbreviation
Fuel Rail diesel PSI	0 to 95,050	PSI	FR PSI
Fuel Rail dsl 10kPa	0 to 65535	10kPa	FR 10k

Fuel rail pressure at the engine relative to atmosphere (Gauge pressure), in Pounds per Square Inch (PSI).

Wide O² Sensor Output lambda

Gauge name	Range	Units	Abbreviation
Bank1 wide O ₂ Sensor 1 lambda	0 to 1.999	N/A	Bnk1 λ1
Bank1 wide O ₂ Sensor 2 lambda			Bnk1 λ2
Bank1 wide O ₂ Sensor 3 lambda			Bnk1 λ3
Bank1 wide O ₂ Sensor 4 lambda			Bnk1 λ4
Bank2 wide O ₂ Sensor 1 lambda			Bnk2 λ1
Bank2 wide O ₂ Sensor 2 lambda			Bnk2 λ2
Bank2 wide O ₂ Sensor 3 lambda			Bnk2 λ3
Bank2 wide O ₂ Sensor 4 lambda			Bnk2 λ4

Wide band O₂ sensor output Lambda. Lambda is the measure of the actual Air to Fuel ratio as compared to the ideal or Stoichiometric value. It is a ratio and has no units.

$$\lambda = \frac{\text{Air}_{\text{MASS}}/\text{Fuel}_{\text{MASS}} (\text{Actual})}{\text{Air}_{\text{MASS}}/\text{Fuel}_{\text{MASS}} (\text{Stoichiometric})}$$

λ = 1 = ideal mixture

λ > 1 = lean mixture

λ < 1 = rich mixture

EGR Commanded

Gauge name	Range	Units	Abbreviation
EGR % Flow	0 to 100	%	EGR% flow

The percent of flow through the Exhaust Gas Recirculation (EGR) valve, where 0% is closed and 100% is wide open. This is the commanded value indicating that the Engine Control Module (ECM) is requesting the EGR to have the desired flow. The actual flow may be different if there is an issue with the EGR.

EGR Error

Gauge name	Range	Units	Abbreviation
EGR % Error	0 to 100	%	EGR %Err

Exhaust Gas Recirculation (EGR) valve error is a percent of commanded EGR

$$\text{EGR Error} = \frac{\text{EGR (actual)} - \text{EGR (commanded)}}{\text{EGR (commanded)}} \times 100$$

For example, if 20% EGR flow is commanded and 15% is actually delivered, then EGR Error is $(15-20)/20 \times 100 = -25\%$

Evaporative Purge %

Gauge name	Range	Units	Abbreviation
Evaporative Purge %	0 to 100	%	Evap %Prg

Commanded Evaporative Purge percent. A value of 0% is no flow, and a value of 100% is wide open maximum flow. This is a commanded value indicating that the ECM is requesting the % flow. The actual flow may not match.

Fuel Level %

Gauge name	Range	Units	Abbreviation
Fuel Level %	0 to 100	%	Fuel Lvl%

This is the raw output of the fuel tank level sensor. However, this input is averaged such that sloshing will not cause erratic behavior. The fuel sensor is sampled every second and averaged with the previous 30 samples.

Warm-ups Since Trouble Codes Cleared

Gauge name	Range	Units	Abbreviation
Warm ups - TC cleared	0 to 255	Warm ups	Wups TC

Once trouble codes are cleared, this gauge counts the number of times the engine temperature rises from 40 F to 160 F, or 140F for diesels. The max count value is 255. Once 255 is reached, the count will remain at 255 until trouble codes are again cleared.

Distance Since Trouble Codes Cleared

Gauge name	Range	Units	Abbreviation
mi since TC cleared	0 to 40,722	miles	mi TC
km since TC cleared	0 to 65,535	kilometers	km TC

Once trouble codes are cleared, this gauge measures the number of miles driven. The max value is 40,722 miles. Once 40,722 miles is reached, the count will remain at 40,722 until trouble codes are again cleared.

Evaporative Vapor Pressure

Gauge name	Range	Units	Abbreviation
Evap Vapor PSI	-1.188 to 1.188	PSI	Evp PSI
Evap Vapor Pa	-8192 to 8192	Pa	Evp Pa

This pressure value is normally obtained from a sensor located in the fuel tank or a sensor in an evaporative system vapor line.

Barometric Pressure

Gauge name	Range	Units	Abbreviation
Barometric inHg	0 to 75.3	inHg	Baro inHg
Barometric kPa	0 to 255	kPa	Baro kPa

Barometric pressure

Catalytic Converter Temperature

Gauge name	Range	Units	Abbreviation
Cat Bank 1 Sensor 1 Temperature	-40 to 11,756	°F	Cat B1S1
Cat Bank 2 Sensor 1 Temperature			Cat B2S1
Cat Bank 1 Sensor 2 Temperature	-40 to 6514	°C	Cat B1S2
Cat Bank 2 Sensor 2 Temperature			Cat B2S2

Catalytic Converter temperature. Bank1 is the Cat through which the exhaust from cylinder #1 passes. Typical temps should not exceed 900°C / 1650°F. Excess temps can damage the converter.

Battery Voltage

Gauge name	Range	Units	Abbreviation
Battery Voltage	0 to 65.535	Volts	Bat volt

Voltage as measured at the Electronic Control Module. This is typically the same as Battery voltage.

Load absolute %

Gauge name	Range	Units	Abbreviation
Load absolute %	0 to 95 0 to 400	%	Load abs%

Alternate to “% Engine Load” this gauge ranges from 0 to 95% for normally aspirated engines and 0 to 400% for boosted engines. This gauge is linearly correlated to Brake Torque

AFR Commanded ratio

Gauge name	Range	Units	Abbreviation
AFR commanded ratio	0 to 1.999		AFR cmd

Fuel Air Commanded ratio. This is the value of Lambda requested by the ECM
= (Stoichiometric F/A ratio) / (Actual F/A ratio) >1 is lean, <1 is rich.

To determine the actual A/F ratio commanded, multiply this value by 14.64

For example. If this value is 0.90, the commanded Air Fuel Ratio is 0.90* 14.64 = 13.17 parts air to one part fuel.

Relative Throttle Position %

Gauge name	Range	Units	Abbreviation
Rel Throttle Pos %	0 to 100	%	Rel TP %

Relative or learned throttle position. A throttle position sensor may never return to its minimum position, but instead closed throttle may always be greater than the TP Sensor’s absolute minimum. This throttle position gauge adjusts for this true closed throttle position. When the throttle is closed, this gauge will read 0% regardless of the details of the absolute throttle position. The relative position value is calculated as follows:

$$\text{Relative \%} = \frac{(\text{TP output}) - (\text{TP output closed})}{(\text{TP output max})} \times 100$$

Example: If the output of the TP is 1V when closed and 10 volt when wide open, an output of 5V would be: $(5-1)/10 \times 100 = 40\%$

Note: This means that this gauge will likely never reach 100%

Ambient Air Temperature

Gauge name	Range	Units	Abbreviation
Ambient Air Temp °F	-40.0 to 419.9	°F	Amb °F
Ambient Air Temp °C	-40.0 to 215	°C	Amb °C

Outside ambient air temperature

Accelerator Pedal Position

Gauge name	Range	Units	Abbreviation
Accel Pedal Pos1 %	0 to 100	%	Ped1 Pos%
Accel Pedal Pos2 %			Ped2 Pos%

The percentage that the throttle Accelerator Pedal is pressed. This is the absolute output from the accelerator pedal position sensor as a percent of the sensor’s max value. The un-pressed and fully pressed positions will likely not be equal to 0% and 100% respectively. For example, the physically un-pressed position may correspond to an absolute position of 8%. Pedal Position 2 is for vehicles with a second throttle Position Sensor

Throttle Position Commanded

Gauge name	Range	Units	Abbreviation
Cmd Throttle Pos %	0 to 100	%	Cmd TP %

The percent throttle requested by the ECM. Used on electrically driven throttles.

When the driver presses the accelerator pedal, the ECM converts the output of the Pedal position sensor to a corresponding throttle position commanded %. The electrical throttle position drive then opens the throttle by the commanded %.

Mass Air Flow 2

Gauge name	Range	Units	Abbreviation
Mass Air Flow 2 g/s	0-999.9	grams/second	MA2 g/s

Mass Air Flow (MAF) is the Mass of air entering into the engine. On vehicles with actual MAF Sensors, there will be two gauges, this gauge and Mass Air Flow 1. Mass Air Flow 1 is the raw output from the MAF sensor, whereas Mass Air Flow Sensor 2 is the calibrated version used by UltraGauge to calculate MPG.

The Mass Air Flow is calculated for vehicles that do not have a MAF sensor but rather use a MAP (manifold absolute pressure) sensor. In this case, MAF is calculated by monitoring several engine sensors, such as MAP, RPM, Vehicle Speed and others.

Instantaneous MPG, KPL, L/100k

Gauge name	Range	Units	Abbreviation
Instantaneous MPG	0 to 999.9	Miles/gallon	Inst MPG
Instantaneous KPL	0 to 999.9	Kilometers/Liter	Inst KPL
Instantaneous L/100k	0 to 999.9	Kilometers/100Liters	Inst L/K

Instantaneous Fuel Economy

Average MPG Average KPL Average L/100k

Gauge name	Range	Units	Abbreviation
Average MPG - general	0 to 999.9	Miles/gallon	Ave MPG
Average KPL - general	0 to 999.9	Kilometers/Liter	Ave KPL
Average L/100k -general	0 to 999.9	Liters /100 Kilometers	Ave L/K

Average Fuel Economy. Average fuel economy is calculated based upon the actual fuel used and the distance traveled. Part of the Group of “General” gauges.... as opposed to “Trip” Gauges. This gauge is reset by selecting:

MENU → Gauge/Page Menu .. → Zero Ave MPG, G/H

Average MPH Average KPH

Gauge name	Range	Units	Abbreviation
Average MPH - general	0 to 999.9	Miles/hour	Ave MPH
Average KPH - general	0 to 999.9	Kilometers/hour	Ave KPH

Average speed. Part of the Group of “General” gauges.... as opposed to “Trip Gauges.

Reset by selection **MENU → Gauge/Page Menu .. → Zero Ave Speed**

Distance

Gauge name	Range	Units	Abbreviation
Distance - general	0 to 99999	Miles Kilometers	Gen dst
Distance - trip			Trp dst
Distance - Oil			Oil dst
Distance - Service			Srv dst

All four distances gauges can independently measure miles traveled and can be used for any purpose desired

Oil	Intended to track the miles since the last oil change. With each oil change, reset this gauge: MENU → Gauge/Page Menu .. → Zero Oil Distance. By Default the Oil Distance alarm is enabled and set to 3000 miles.
Service	Intended to track service intervals such as 15K, 30K or 60K mile service intervals. Reset: MENU → Gauge/Page Menu .. → Zero Service Dist. Use in combination with Alarms for maximum effectiveness. By default this alarm is disabled.
Trip	Trip Distance is part of the group of five trip gauges. All trip gauges are reset as a group. MENU → Gauge/Page Menu .. → Zero All Trip
General	Primarily used to calculate Average Miles per Gallon. Normally an internal value, but made available to aid in understanding the Average MPG Calculation. Average MPG is found by dividing General Distance by Gallons used, where Gallons is “Gallons – general”. This gauge is reset by resetting the Average MPG: MENU → Gauge/Page Menu .. → Zero Ave MPG

TRIP GAUGES

Gauge name	Range	Units	Abbreviation
Trip Miles	0 to 99,999	Miles	mi trp
Trip Kilometers	0 to 99,999	Kilometers	km trp
Trip Average MPG	0 to 999.9	Miles/gallon	MPG trp
Trip Average KPL	0 to 999.9	Kilometers/Liter	KPL trp
Trip Average L/100km	0 to 999.9	Liters/100km	L/K trp
Trip Ave MPH	0 to 999.9	Miles/hour	MPH trp
Trip Ave KPH	0 to 999.9	Kilometers/hour	KPH trp
Trip Gallons used	0 to 999.9	Gallons	Gals trp
Trip Liters used	0 to 999.9	Liters	Ltrs trp
Trip Ave Gallons/Hour	0 to 99.99	Gallons/hour	G/H trp
Trip Ave Liters/Hour	0 to 99.99	Liters/hour	L/H trp
Trip Run Time	0 to 999.59	Hours:minutes	Run trp
All trip gauges are zeroed by selecting: MENU → Gauge/Page Menu .. → Zero All Trip Trip data is saved each time the ignition is set from RUN to OFF. Never unplug UltraGauge while the engine is running or current trip data will be lost.			

Distance	Distance traveled since trip was reset
Average MPG, KPH, L/100km	Average fuel economy. Based upon trip Fuel used and trip Distance
Average speed	Average speed accumulated since trip was reset.
Fuel Used	Fuel used since trip was reset.
Fuel rate	Average Fuel rate since trip was last reset.
Run Time	Run time in hours: minutes. This timer is runs only when the engine runs. When the max value of 999 hours and 59 minutes is reached this timer stops. NOTE: The alarm for this gauge is set in hours and fractions of hours, not Hours and minutes. A setting of 0.5 is 30 minutes.

Short TRIP GAUGES

Gauge name	Range	Units	Abbreviation
Srt Trip Miles	0 to 9,999.9	Miles	mi srt
Srt Trip Kilometers	0 to 9,999.9	Kilometers	km srt
Srt Trip Average MPG	0 to 999.9	Miles/gallon	MPG srt
Srt Trip Average KPL	0 to 999.9	Kilometers/Liter	KPL srt
Srt Trip Average L/100km	0 to 999.9	Liters/100km	L/K srt
Srt Trip Average MPH	0 to 999.9	Miles/hour	MPH srt
Srt Trip Average KPH	0 to 999.9	Kilometers/hour	KPH srt
Srt Trip Gallons used	0 to 99.99	Gallons	Gals srt
Srt Trip Liters used	0 to 99.99	Liters	Ltrs srt
Srt Trip Gallons/Hour	0 to 99.99	Gallons/hour	G/H srt
Srt Trip Liters/Hour	0 to 99.99	Liters/hour	L/H srt
Srt Run Time	0 to 999.59	Hours:minutes	Run srt
All short trip gauges are zeroed each time the ignition is switched from RUN to OFF.			

Distance	Distance traveled since ignition
Average MPG, KPL, L/100km	Average fuel economy. Based upon Fuel used and Distance traveled since ignition
Average MPH	Average Miles Per Hour accumulated since ignition
Fuel Used	Fuel used since ignition.
Fuel Rate	Average Fuel rate since ignition.
Run Time	Run time in hours: minutes. This timer is runs only when the engine runs. When the max value of 999 hours and 59 minutes is reached this timer stops. NOTE: The alarm for this gauge is set in hours and fractions of hours, not Hours and minutes. A setting of 0.5 is 30 minutes.

Boost Pressure

Gauge name	Range	Units	Abbreviation
Boost Pressure PSI	-14.60 to 22.50	PSI	Bst PSI
Boost Pressure kPa	-101 to 155	kPa	Bst kPa

Boost pressure is the pressure inside the intake manifold relative to atmospheric pressure. It is also commonly known as Manifold Gauge Pressure. For vehicles which also support the Barometric gauge, Boost pressure is relative to the barometric pressure. For vehicles not supporting a barometric gauge, the ambient barometric pressure is considered to be constant @ 14.64 PSI or 101 kPa.

Horsepower 1 Kilowatts 1

Gauge name	Range	Units	Abbreviation
Brake Horsepower 1	0 to 9999.9	HP	HP1
Brake Kilowatts 1	0 to 9999.9	kW	KW1

Horsepower 1 and Kilowatts 1 are derived from the vehicle's Engine Control module and based on a percentage of maximum Torque. This gauge must first be configured by setting the maximum torque for the target vehicle. The maximum torque is a common parameter that can be found by searching the internet for the engine specification for your vehicle. The torque is commonly specified as a Torque @ a particular RPM. For example, 200 ft.lbs @ 3200 RPM. The Maximum torque is set via the menu system: **MENU → Vehicle Setup.. → More.. → Set HP1 Max Torque**

The torque may be entered in either ft.lbs or N.m

Note For modified engines, alter the Torque value to represent the new estimated Torque.

Note. Horsepower/KW 1 & 2 are provided as competing methods of determining the power output of the engine. In general HP1 is likely to be more accurate. However, use which ever provides the most reasonable results for your vehicle.

Torque 1

Gauge name	Range	Units	Abbreviation
Torque 1 ft.lbs	0 to 999.9	Ft.lbs	TRQ1 ftlb
Torque 1 N.m	0 to 999.9	N.m	TRQ1 Nm

Horsepower 1 and Kilowatts 1 are derived from the vehicle's Engine Control module. This gauge must first be configured by setting the maximum torque for the target vehicle. The maximum torque is a common parameter that can be found by searching the internet for the engine specification for your vehicle. The torque is commonly specified as a Torque @ a particular RPM. For example, 200 ft.lbs @ 3200 RPM. The Maximum torque is set via the menu system:

MENU → Vehicle Setup.. → More.. → Set HP1 Max Torque

Note. Torque 1 & 2 are provided as competing methods of determining the torque output of the engine. In general Torque 1 is likely to be more accurate. However, use which ever provides the most reasonable results for your vehicle.

Horsepower 2 Kilowatts 2

Gauge name	Range	Units	Abbreviation
Brake Horsepower 2	0 to 9999.9	HP	HP2
Brake Kilowatts 2	0 to 9999.9	kW	KW2

Horsepower 2 and Kilowatts 2 are derived based on the amount of energy being consumed by the engine and the engine's efficiency. By default the efficiency is assumed to be 24%. This means that only 24% of the energy contained in the fuel actually produces power or torque output. 24% is an good average for typical modern vehicles. This value can be adjusted if more specific information is available via the menu system:

MENU → Vehicle Setup.. → More.. → Set HP2 Efficiency

Note. Horsepower/KW 1 & 2 are provided as competing methods of determining the power output of the engine. In general HP1 is likely to be more accurate. However, use which ever provides the most reasonable results for your vehicle. HP2 is typically better for modified engines. Fuel usage calibration improves the accuracy.

Torque 2

Gauge name	Range	Units	Abbreviation
Torque 2 ft.lbs	0 to 999.9	Ft.lbs	TRQ2 ftlb
Torque 2 N.m	0 to 999.9	N.m	TRQ2 Nm

Torque 2 is derived based on the amount of energy being consumed by the engine and the engine's efficiency. By default the efficiency is assumed to be 24%. This means that only 24% of the energy contained in the fuel actually produces power or torque output. 24% is an good average for typical modern vehicles. This value can be adjusted if more specific information is available via the menu system:

MENU → Vehicle Setup.. → More.. → Set HP2 Efficiency

Note. Torque 1 & 2 are provided as competing methods of determining the power output of the engine. In general TRQ1 is likely to be more accurate. However, use which ever provides the most reasonable results for your vehicle. Torque 2 is typically better for modified engines.

Fuel Level

Gauge name	Range	Units	Abbreviation
Fuel Level - Gallons	0 to fuel tank size	Gallons	Lvl Gals
Fuel Level - Liters	0 to fuel tank size	Liters	Lvl Ltrs

The Fuel Level gauge indicates the number of remaining gallons/liters in the fuel tank. This value is determined one of two ways, depending on the **Fuel Sender Mode** Setting. When the Fuel Sender Mode is set to **Disabled** or **Smart**, the fuel level is calculated based upon fuel used. When the Fuel Sender Mode is set to **Enabled**, the fuel level is calculated directly from the fuel tank sensor.

When the **Fuel Sender Mode** is set to **Disabled**, it is necessary to inform UltraGauge manually that the tank has been filled. This is done via the menu system by selecting **MENU → Fuel Menu .. → Fuel fill up**. This can also be accomplished by pressing and holding the **UP** key for three seconds while UltraGauge is showing the Main Gauge display. Once Fuel Fill-Up is done, the Fuel Level, TTE and DTE will adjust.

To determine if your vehicle supports a fuel level sensor, select **MENU → Fuel Menu .. → Fuel Sender Mode**. If the response is "**No Fuel Sensor Found**", no sensor is available via the OBDII. Otherwise, the vehicle supports the sensor and UltraGauge will automatically use this sensor to determine the Fuel Level. Some vehicles incorrectly report the support of a fuel level sensor. For those vehicles the reported fuel level will be frozen or inaccurate. In this situation, the use of the fuel level sensor must be disabled. To disable the fuel level sensor, select **MENU → Fuel Menu .. → Fuel Sender Mode**. Then select **Disabled**.

NOTE:

There can be more fuel than indicated when the sensor reports 100% full, and there can be a reserve of fuel when the sensor reports 0 gallons remaining. When the fuel level is calculated, fuel level can report a negative number indicating that you have used more fuel than your reported fuel tank size. This is normal as there is always an unreported reserve. Vehicle Tank sensors are also notoriously inaccurate by as much as +3 gallons. It is recommended to set the Fuel Sender setting to either disabled or Smart. See the Fuel Sender Setting section for additional details

RUN TIME (General)

Gauge name	Range	Units	Abbreviation
Run Time general	0 to 999.59	Hours:Minutes	Run tme

When ever the engine is running this timer is running. The time is displayed in hours and minutes, with the max time being 999 hours and 59 minutes.(41.6 days). Once this value is reached the timer will stop. This timer can be reset by selecting: **MENU → Gauge/Page Menu .. → Zero Run Time**.

NOTE: There is also two sister gauges; Run Time Trip and Run Time Short trip

NOTE: The alarm for this gauge is set in hours and fractions of hours, not Hours and minutes. A setting of 0.5 is 30 minutes.

Instantaneous Gallons/Hour Liters/Hour

Gauge name	Range	Units	Abbreviation
Inst Gals/Hour	0 to 99.99	Gallons/hour	Inst G/H
Inst Liters/Hour	0 to 99.99	Liters/hour	Inst L/H

Provides the real time measure of the rate of fuel consumption per hour.

Distance To Empty (DTE)

Gauge name	Range	Units	Abbreviation	Fuel Sensor
Miles to Empty km to Empty	-9999.9 to 9999.9 -9999.9 to 9999.9	Miles km	DTE	Disabled/Smart
Miles to Empty km to Empty	0 to 9999.9 0 to 9999.9	Miles km	DTE	Enabled

DTE provides an estimate of the number of miles before the fuel tank is Empty based upon average miles per gallon. UltraGauge uses either the vehicle's Fuel Level Sensor, if present via the OBDII, or it calculates the remaining fuel by continuously tracking the amount of fuel used. See the Fuel Sender Section for more details.

With Fuel Tank Sensor:

When a sensor is present via OBDII, UltraGauge can determine when the tank is refilled and DTE will be updated automatically. The distance to empty is determined by the current general average miles per gallon gauge; **Average MPG**, and the number of gallons in the fuel tank. When a fuel level sensor is present, the DTE Gauge Range is 0 to 9999.9 miles

Without Fuel Tank Sensor:

When a fuel level sensor is not available, or the Fuel Sender Mode is set to *Disabled*, UltraGauge has no ability to sense the actual fuel level. It is necessary that UltraGauge be informed each time the tank is filled. To do this, select **MENU → Fuel Menu .. → Fuel fill up** or by holding the **UP** key for 3 seconds. UltraGauge then assumes that the tank has been filled and contains the number of gallons/liters specified under **MENU → Vehicle Settings → Set Fuel Tank Size**.

Selecting **MENU → Fuel Menu .. → Fuel fill up** affects gauges **DTE**, **TTE** and **Fuel Level**. No other gauges are affected.

NOTE: DTE is determined by the fuel level and the average MPG. This average MPG is the “general” MPG. If Distance traveled is less than 0.1 miles or Gallons Used is less than 0.01 Gallons, UltraGauge will assume an MPG Average of 5 MPG.

NOTE: Selecting **MENU → Fuel Menu .. → Fuel fill up** will not affect the **Average MPG** or **Average MPG – Trip** gauges.

NOTE: When a fuel level sensor setting is set to *Disabled* or *Smart*, the distance to empty can become negative and the range is -9999.9 to 9999.9 miles. A negative number indicates the number of miles traveled or gallons used since the estimated remaining fuel reached zero gallons. There is always an amount of fuel in the tank and in the system that the vehicle's fuel level sensor cannot detect. Hence it is likely that the vehicle can travel several miles beyond the point that DTE becomes zero.

NOTE: Do not rely on this gauge until you have become comfortable with the accuracy of UltraGauge.

Time To Empty (TTE)

Gauge name	Range	Units	Abbreviation	Fuel Sensor
Time to Empty	-99:59 to 999:59	Hours:Minutes	TTE	Disabled/Smart
Time to Empty	0 to 999:59	Hours:Minutes	TTE	Enabled

TTE provides an estimate of the number of hours and minutes remaining before the fuel tank is Empty and is based upon Average Gallons/Hour gauge. UltraGauge uses either the vehicle's Fuel Level Sensor, if present, or it calculates the remaining fuel by continuously tracking the amount of fuel used. See the Fuel Sender Section for more details.

Zeroing the Average Gallons/Hour gauge restarts TTE. Average G/H is zeroed by selecting:

MENU → Gauge/Page Menu .. → Zero Ave MPG, G/H

With Fuel Tank Sensor:

When a sensor is present, UltraGauge can determine when the tank is refilled and TTE/DTE will be updated automatically. The Time to empty is determined by the average fuel use and the number of gallons in the fuel tank. When a fuel level sensor is present, the TTE Gauge Range is 0 to 999 hours and 59 minutes.

Without Fuel Tank Sensor:

When a fuel level sensor is not available, or the Fuel Sender Mode is set to *Disabled*, UltraGauge has no ability to sense the actual fuel level. It is necessary that UltraGauge be informed each time the tank is filled. To do this, select **MENU → Fuel Menu .. → Fuel fill up** or by holding the **UP** key for 3 seconds. UltraGauge then assumes that the tank has been filled and contains the number of gallons specified under **MENU → Vehicle Settings → Set Fuel Tank Size**.

Selecting **MENU → Fuel Menu .. → Fuel fill up** affects gauges **DTE**, **TTE** and **Fuel Level**. No other gauges are affected

NOTE: When a fuel level sensor setting is set to *Disabled* or *Smart*, Time to Empty can become negative and the range is -99:59 to 999:59 hours:mins. A negative number indicates the elapsed time since the estimated remaining fuel reached zero gallons. There is always an amount of fuel in the tank and in the system that the vehicle's fuel level sensor cannot detect. Hence it is likely that the vehicle can travel several miles beyond the point that TTE becomes zero.

NOTE: Do not rely on this gauge until you have become comfortable with the accuracy of UltraGauge.

NOTE: The alarm for this gauge is set in hours and fractions of hours, not Hours and minutes. A setting of 0.5 is 30 minutes.

Volumetric Efficiency % (MAP vehicles only)

Gauge name	Range	Units	Abbreviation
VE (MAP vehicles only)	0 to 100	%	VE %

Volumetric efficiency is a measure of how fully your vehicle can fill its cylinders with the fuel/air mixture on the intake stroke. For example, a vehicle with a VE of 50% is able to fill its cylinder with 50% of its potential. UltraGauge uses several engine sensors to determine the VE dynamically. This Gauge is only shown if the MAP sensor is present.

If Adaptive Volumetric Efficiency has been enabled, this gauge will provide the Volumetric Efficiency percentage in real time. Adaptive Volumetric Efficiency can be controlled via the menu system by selecting:

MENU → Vehicle Setup .. → VE Enable (MAP only)
MENU → Vehicle Setup .. → VE RPM (MAP only)

To determine if your vehicle uses a MAP sensor, access the menu; **MENU → UltraGauge Setup.. → Version**. This will display **MPG sensor: MAP, MAF** or **None**

UltraGauge Temperature

Gauge name	Range	Units	Abbreviation
UG Temperature	0 to 232	°F	UG °F
UG Temperature	0 to 111	°C	UG °C

Internal temperature of UltraGauge. Avoid possible malfunction due to high dash temperatures on sunny summer days. By default the high alarm is enabled and set to 145 °F. UltraGauge will continue to operate even when extreme high temperature is present. Due to internal heating, it is common for this gauge to report temperatures in the range of 125 -130 °F on a bright day, while mounted on the dash in sunlight, when the cabin temperature is 75-80 °F. If temperatures in excess of 140°F are seen, check that the cooling vents are not blocked. If the temperature rises above 140°F, the Backlighting will automatically dim to 65%. The backlighting is the primary source of internal heat and a temporary reduction to 65% will greatly reduce the temperature. Setting the Max Backlighting to a value of 80% or less is recommended. Generally the amount of additional light produced when set above 80% is difficult to perceive. UltraGauge will naturally cool down as the interior of the vehicle is cooled. Setting the vehicle's vent controls to defrost will direct cool air to the dash area and more quickly cool UltraGauge. While UltraGauge is designed to operate under elevated temperatures, some customers have painted the back half of UltraGauge white to reflect the heat of the sun. This can result in a significant decrease in temperature when UltraGauge is dash mounted. This is more for piece of mind and is not necessary.

NOTE: When the vehicle is started, after being off for more than 15 minutes, The UltraGauge Temperature will approximately equal the cabin/dash temperature. The internal backlighting circuits, having been activated by the vehicle start, will then cause UltraGauge's internal temperature to slowly increase above cabin temperature.

Gauge/Page Menu ..

Select Gauges ..

MENU → Gauge/Page Menu .. → Select Gauges..

Used to select and assign gauges to pages and zones. See the sections; *Gauge Pages and Zones* and *Gauge Zone Assignments*.

Page settings ..

MENU → Gauge/Page Menu .. → Page settings ..

Provides gauge page configuration settings

Unassign All Gauges

MENU → Gauge/Page Menu .. → Unassign All Gauges

Un-assigns all gauges from all pages and zones. Not commonly used. Can be used when it is desired to reassign all gauges. Once unassigned the Main display will show no gauges.

Load Default Gauges

MENU → Gauge/Page Menu .. → Load Default Gauges

Restores the factory default Gauge assignments. When shipped UltraGauge has the following default gauge assignments:

Page	Zone	Gauge	Page	Zone	Gauge
1	1	Instantaneous MPG	5	1	
	2	Average MPG – General		2	
	3	Instantaneous Gallons/Hour		3	
	4	Fuel Level		4	
	5	Time To Empty		5	
	6	Distance to Empty (DTE)		6	
	7			7	
	8			8	
2	1	Trip Average MPH	6	1	
	2	Trip Average MPG		2	
	3	Trip Fuel Used		3	
	4	Trip Ave Gallons/Hour		4	
	5	Trip Run Time		5	
	6	Trip Miles		6	
	7			7	
	8			8	
3	1	Srt Trip Ave MPG	7	1	
	2	Srt Trip Ave G/H		2	
	3	Srt Trip Gallons used		3	
	4	Srt Trip Run Time		4	
	5	Srt Trip Average MPH		5	
	6	Srt Trip Miles		6	
	7			7	
	8			8	
4	1	Boost Pressure PSI			
	2	Mass Air Flow 2			
	3	Engine Coolant Temperature			
	4	UG Temperature F			
	5	Oil Distance			
	6	Service Distance			
	7				
	8				

Page Settings ..

Page Display Format

MENU → Gauge/Page Menu .. → Select Gauge/Page .. → Page settings .. → Page Display Format

Each of the 7 gauge pages can be configured to display 4, 6 or 8 gauges at a time.

The 4 & 6 gauge page format actually display 5 & 7 gauges as the Open/Closed loop indicator is also displayed at the top right of the screen.

Page Enables

MENU → Gauge/Page Menu .. → Select Gauge/Page .. → Page settings .. → Page Enables

Each of the 7 gauge pages can be enabled or disabled. When disabled, advancing to the next page will skip over the disabled page. This is true for both manually advancing the displayed page or via the Auto Page feature.

NOTE: If all pages are disabled, UltraGauge will re-enable page 1, as at least one page must always be enabled.

Page Refresh Time

MENU → Gauge/Page Menu .. → Select Gauge/Page .. → Page settings .. → Page Refresh Time

Page Refresh rate	Min	Default	Max
	0.3 seconds	1.0 second	2 seconds

Sets the display refresh time. Each time the display is refreshed, UltraGauge reads parameters from the vehicle's computer (ECM) and updates the displayed gauges. As the time is reduced, UltraGauge consumes more bus bandwidth requesting and transferring data. As a result this setting should be used with caution. In many vehicles the OBDII port is connected to a vehicle wide information bus. This bus is used by various vehicle modules to communicate. There is a finite bandwidth on the bus and setting the refresh time smaller and smaller will consume more and more bandwidth to the point that it could impair regular bus communication between system modules. This is especially true for 9141 and KWP2000 protocols, and to a lesser degree J1850 and Ford Protocols. The CAN protocol has considerably more bandwidth than early protocols, however, there is a good deal more communication on CAN equipped vehicles.

When reducing the refresh time, note any abnormal side effects such as intermittent "Err" being display, the Check Engine Light becoming illuminated, or impaired engine performance or altered shift points. Should any of these conditions occur, increase the Page Refresh time until the issue no longer occurs.

Vehicles with the 9141 and KWP2000 protocols should run "KWP/9141 optimizer" before changing the Page Refresh Time.

Auto Page Advance

MENU → Gauge/Page Menu .. → Select Gauge/Page .. → Page settings .. → Auto Page Advance

Enables or disables the Auto Page Advance feature. UltraGauge can display seven pages of gauges. Auto page Advance cycles through pages at programmable intervals in order of increasing page number. When the last page is reached, UltraGauge advances back to the first page. The interval can be set from 1 to 255 seconds*.

Each page can be programmed with a unique value. For example, page 1 could be set to display for 10 seconds*, and page 2 could be set to display for 20 seconds*. Pages which have been disabled will not be displayed.

For additional information on pages, see the **GAUGE PAGES & ZONES** section.

* **NOTE:** While the value is set in terms of seconds, the units are actually the time at which the display is refreshed.

For example, when the Page refresh time is set to the default of 1.0 seconds, then this setting is in terms of seconds.

If the refresh time is reduced to 0.5 seconds, then this settings is in terms of ½ seconds. For example, if the Auto Page Advance was set to 20, and the Refresh Time was set to 0.5 seconds, the page would advance after 10 seconds.

Auto Page Time

MENU → Gauge/Page Menu .. → Select Gauge/Page .. → Page settings .. → Auto Page Time

Provides the ability to independently set the time that each of the 7 gauge pages are displayed before UltraGauge advances to the next page. The time may be set from 1 to 255 seconds

FUEL MENU ..

Partial Tank fill up

MENU → Fuel Menu.. → Partial Tank fill up

It is always recommended to fill-up your fuel tank completely and then use *MENU → Fuel Menu .. → Fuel fill up*. However, Partial tank fill ups are supported. Simply select *MENU → Fuel Menu .. → Partial Tank fill up*, and then enter the amount of fuel added to the fuel tank. To simplify entry, UltraGauge will always display an initial partial fill up amount that is 60% of the maximum amount that could be added, rounded down to the whole gallon. UltraGauge will only allow a maximum amount of fuel to be entered that corresponds to the amount of fuel missing from the tank. If you pump more fuel than UltraGauge will allow, this likely means that the Fuel Tank Size setting has been set too low.

After entering the amount of fuel, UltraGauge will briefly display the current fuel level at the bottom of the screen.

Using Partial Fill-up is not recommended since small errors in the amount of added fuel, the tank size, and calculated fuel amounts are cumulative with each partial fill-up. This can result in inaccurate values of Fuel Level and DTE. For this reason, it is recommended to perform a tank fill up periodically to reduce any accumulated error.

Empty Fuel Tank

MENU → Fuel Menu.. → Empty Fuel Tank

Informs UltraGauge that the Fuel Tank is empty. This affects the Fuel Level, TTE and DTE gauges. Typically *Empty Fuel Tank* is used along with *Partial Tank fill up* to set the initial amount of fuel in the fuel tank.

Fuel fill up

MENU → Fuel Menu.. → Fuel fill up

Use this menu item to inform UltraGauge that the tank has been completely filled. Once filled, UltraGauge assumes the amount of fuel in the tank is equal to the fuel tank size. Once initiated, UltraGauge will then adjust the Fuel Level, TTE and DTE gauges accordingly.

This menu item is an alternative to the quick Tank fill up initiated by pressing and holding the UP key until the Fuel fill up is triggered, while in the main display.

This menu item is only necessary for vehicles not reporting a fuel tank sensor. For vehicles with a fuel tank sensor that is operating in smart mode, tank fill up is automatic and there should be no need to use this menu item. However, *Fuel fill up* can be used and will result in the equivalent of an automatic tank fill up.

Level Sender Mode

MENU → Fuel Menu .. → Level Sender Mode

UltraGauge automatically determines if the vehicle supports a fuel level sensor. If no sensor is available, the message “**No Fuel Sensor Found**” will be displayed when *MENU → Fuel Menu .. → Level Sender Mode* is selected. If not present, see the *Disabled* setting below for additional details

If a Fuel Level Sensor is present, this menu item will offer three options:

Disabled

When disabled, the fuel sensor, if present, is ignored and UltraGauge continually calculates the amount of fuel used. The result is used by the **Fuel Level**, **TTE** and **DTE** gauges. In this mode it is necessary to inform UltraGauge each time the tank is filled. To do so, hold the UP key until a “Tank Full” message appears. Alternatively, select *MENU → Fuel Menu .. → Fuel fill up* or optionally, *MENU → Fuel Menu ..Partial Tank Fill Up* can be selected and amount of fuel pumped can be entered. After signaling the addition of fuel, the **Fuel level**, **TTE** and **DTE** will be recalculated.

Enabled

When Enabled, fuel level is determined from the vehicles fuel level sensor. In this mode UltraGauge continually monitors the fuel level sensor and updates the Fuel Level, TTE, DTE, and Fuel Level % gauges. As a result Fuel Fill-ups are automatic.

Note:

As fuel sloshes around in the tank, from driving around corners, going up or down hills, braking or accelerating, the Level Sender Mode can provide inaccurate readings. UltraGauge attempts to smooth the results to lessen this affect. However, for some vehicles with significant sender variation, this issue may be seen in the form of DTE and Fuel Level variation. To avoid this issue, use the Smart Level Sender Mode setting.

Smart

Smart Mode determines the fuel level by continually calculating the fuel used. Smart mode also monitors the fuel sender to determine if a tank fill-up has occurred. There are two user configurable thresholds that are used to determine when a Tank fill-up has occurred; Low Threshold and Full Threshold. When the fuel level falls below the low threshold, the auto-fill function becomes armed. When the tank is filled and the fuel level exceeds the Full Threshold, UltraGauge triggers a Fill-up event automatically. When this happens UltraGauge assumes the tank has been topped off and contains the amount of fuel equal to the fuel tank size. The Fuel Level, TTE and DTE gauges will adjust automatically.

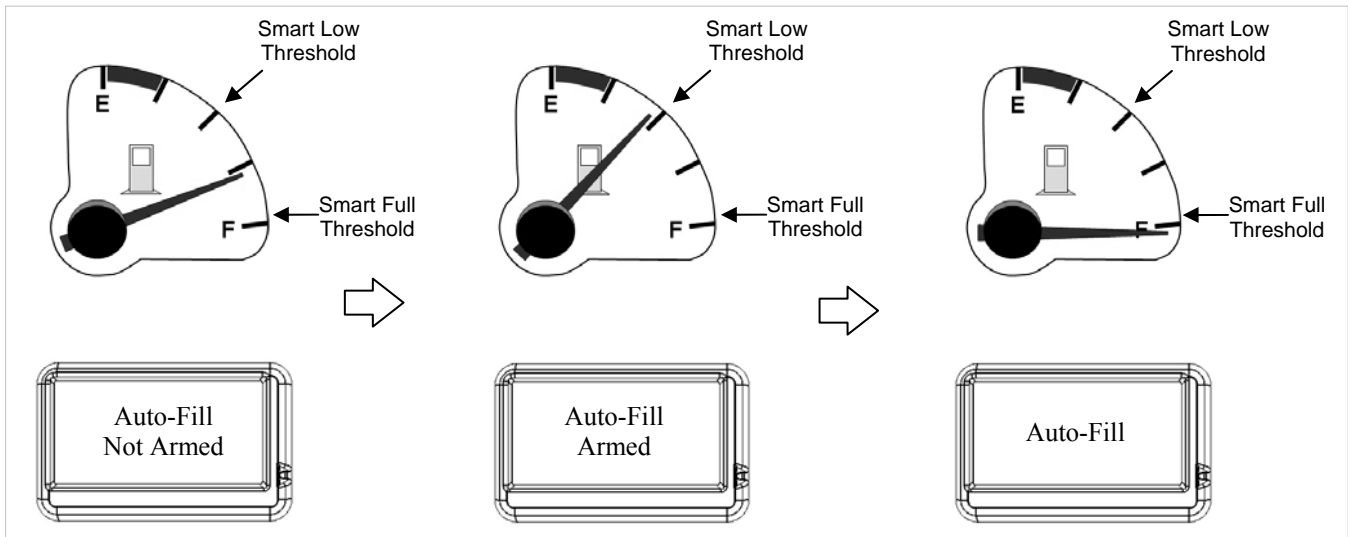

By default the Low Threshold is set to 50% and the full threshold is set to 98%. Setting the Low Threshold too high may cause a false Auto-Fill event to trigger as a result of gas sloshing around in the fuel tank.

NOTE: When changing the mode from **Disabled** or **Enabled** to **Smart**, UltraGauge will automatically estimate the existing fuel in the fuel tank by using the output of the fuel tank sensor. This is best performed while not moving and on level ground. This one-time estimate will alter the Fuel Level, TTE and DTE gauges only.

NOTE:

Some vehicles incorrectly report the presence of a Level Sender Mode or it is improperly implemented¹ or it is defective. In these rare cases the **Fuel Level %** gauge will appear frozen or show a value unrelated to the fuel level. Other gauges that use the Level Sender, including **DTE**, **Fuel Level**, and **Fuel Level %** will also be in error.

In this situation, the fuel level sensor must be disabled. Select **MENU → Fuel Menu .. → Level Sender Mode**. Then select **Disable**.

¹ This issue has been seen on a 2009 Hyundai Elantra. Many other Hyundai years and models have been found to correctly support the fuel level sensor

Smart Full Threshold

MENU → Fuel Menu.. → Smart Full Threshold

Sets the fuel tank level Threshold above where a Smart Fuel fill-up will be initiated. See **MENU → Fuel Menu .. → Level Sender Mode → Smart** for additional details. This menu item is active on vehicles that report the presence of a fuel tank sensor.

Smart Low Threshold

MENU → Fuel Menu.. → Smart Low Threshold

Sets the fuel tank level Threshold below where the Smart Fuel fill-up will be armed. See **MENU → Fuel Menu .. → Level Sender Mode → Smart** for additional details. This menu item is active on vehicles that report the presence of a fuel tank sensor.

Estimate Fuel Level

MENU → Fuel Menu.. → Estimate Fuel Level

When a vehicle supports a fuel tank sensor, **Estimate Fuel Level** will use the fuel sensor to estimate the fuel present in the fuel tank. The results of this estimate will be reflected in the Fuel Level, TTE and DTE gauges. Normally this is only necessary to establish an initial estimate of the fuel in the tank. Normally **Fuel Fill up** or **Partial Tank Fill up** will be used to set the fuel in the tank. Note that once initiated it starts the process which completes after a several seconds once the menu is exited.

Vehicle Setup..

SET ENGINE SIZE

MENU → *Vehicle Setup ..* → *Set Engine Size*

Sets the engine size in liters. This is only important for vehicles that do not have a Mass Air Flow Sensor (MAF). For these vehicles, it is imperative that the engine size be set, otherwise the Mileage Gauges will be inaccurate. The MPG calculation and calibration is also dependent on this setting.

Often the vehicle manufacturer will round the engine size to the nearest tenth for badging and labeling. For example, 5.56L becomes 5.6L. Check the specifications section of the vehicle's owner manual for actual engine size.

SET FUEL TANK SIZE

MENU → *Vehicle Setup ..* → *Set Fuel Tank Size*

Sets the fuel tank size in Gallons. This is used to calculate the fuel level and Distance to Empty Gauges.

If the tank size for your vehicle is specified only in liters, then use the following equation to determine gallons:

$$\text{Gallons} = \text{Liters} \times 0.26417$$

Calibration..

Calibrate MPG/Fuel

MENU → *Vehicle Setup ..* → *Calibration..* → *Calibrate MPG/Fuel*

This calibration is used to fine-tune UltraGauge to accurately measure fuel usage. This calibration is critical, especially for vehicles which use a MAP sensor, diesels and alternative fuels.

- For vehicles that use a MAP sensor*, see the menu section on Adaptive Volumetric Efficiency before proceeding.
- Prior to this calibration, consider performing the distance calibration. See the section: [*Calibrate Distance*](#)
- Calibration can not be performed if less than 4 liters or 1 gallon have been used. It is best to use a full tank or more.

The gauges that depend on fuel usage will not be accurate until this calibration is complete. To perform calibration, please follow these steps.

1. Fill up the fuel tank. Once filled, press and hold the UP key to cause UltraGauge to recognize the fill-up
2. Zero the Average MPG. *MENU* → *Gauge/Page Menu ..* → *Zero Ave MPG, G/H.*
3. At the next fuel fill-up, note the number of gallons/liters used (pumped). Select *MENU* → *Vehicle Setup..* → *Calibration..* → *Calibrate MPG/Fuel* and enter the fuel used. Press *MENU* when complete to set and save the calibration. Use the same fuel station and pump for best results. Alternatively, record and add the actually gallons used over several fill-ups to improve accuracy.
4. The Calibration factor will be displayed at the bottom of the screen.

Congratulations, you have successfully calibrated UltraGauge to your vehicle.

Make note of the calibration factor. If you should ever need to clear your configuration, the calibration factor can be used directly to set the calibration. Simply jump to step #3 and increase or decrease the reported gallons until the calibration factor matches.

Ethanol fuel : Ethanol blends have less energy in the same volume of fuel. Switching between blended and unblended fuel will result in inaccurate fuel usage for vehicles which have a MAP sensor and no MAF sensor. It is recommended to either avoid Ethanol fuel blends, or use only Ethanol fuel blends. Experience has shown that Ethanol results in reduced fuel economy.

* To determine if your vehicle has a MAF sensor, access the menu; *MENU* → *UltraGauge Setup..* → *Version.* This will display *MPG sensor: MAP, MAF* or *None*

Reset MPG/Fuel Cal

MENU → Vehicle Setup .. → Calibration.. → Reset MPG/Fuel Cal

Resets the MPG/Fuel Calibration factor to the factory default of 1.000. Use this to restore the calibration factor if the MPG/Fuel Calibration is performed improperly.

Calibrate Distance

MENU → Vehicle Setup .. → Calibration.. → Calibrate Distance

Use this menu item to calibrate all Distance Gauges. This calibration also directly affects the accuracy of all Speed, MPG and DTE gauges. This calibration is especially necessary for vehicles which no longer have the stock wheels, tire sizes, transmission, or rear-end differential. This calibration will also compensate for inaccuracies in stock speed sensor and the vehicle's distance measurement system. **Perform this Calibration prior to all other calibrations.**

**** Calibration can not be performed unless a distance of at least 4 Kilometers or 2.5 miles have been driven. ****

To perform the distance calibration follow this procedure:

1. Align front tire with first mile marker
2. Reset the trip gauges: **MENU → Gauge Menu → Zero All Trip**
3. Travel to the next mile marker, aligning the front tire to the mile marker
4. Select: **Menu → Vehicle Setup → Calibration → Calibrate Distance**
5. Change the value shown to 1.000 miles*, using the **UP** and **DOWN** keys
6. Press **Menu** to save and set the calibration

Once saved, the calibration factor will be displayed at the bottom of the display.

Many roads will have mile markers, but avoid roads that are not straight. Generally more markers will improve accuracy. The greater your speed between mile markers the better the accuracy of the distance calibration

*If you chose to travel several mile markers, then enter in the number of miles actually driven, for example, 3.000 miles.

NOTE: Unplugging UltraGauge after calibration will not cause loss of calibration.

NOTE: Using the vehicle's odometer to perform this calibration is pointless since the odometer and UltraGauge receive distance information from the same source; the vehicle's ECM.

VE Enable (MAP only)

MENU → Vehicle Setup .. → VE Enable (MAP vehicles only)

Enables Adaptive Volumetric Efficiency. Vehicles use either a Manifold Absolute Pressure (MAP) sensor or a Mass Air Flow (MAF) sensor to determine fuel mixture* Mileage calculations with MAF are much more accurate than with MAP. One issue with MAP is that it is necessary to know the volumetric efficiency(VE) of the engine. Volumetric efficiency (VE) is the measure of the ability to fully fill the cylinders with the fuel/air mixture. VE is different for each engine design. An engine with a 50% VE is one that is able to fill to 50% of capacity on the intake stroke.

Normally when Adaptive VE is not enabled, the VE is automatically set to a fixed average. With Adaptive VE enabled, the VE is automatically adjusted dynamically based upon run time conditions to more accurately determine mileage. For MAP vehicles, the VE can be monitored through the VE gauge. This feature should remain disabled for vehicles that are supercharged or turbo-charged. If enabled, also set the RPM at which the engine achieves peak torque. See *VE RPM* for additional details. The VE% gauge is visible only when a MAP sensor is present in the vehicle.

If enabled, it will then be necessary to run the MPG calibration to achieve best accuracy. For most vehicles Adaptive Volumetric Efficiency will provide improved accuracy of the MPG, Fuel Level, TTE and DTE gauges. In rare cases the adaptive VE may result in less accurate results, in which case it should be disabled.

*To determine if your vehicle uses a MAP or a MAF sensor, access the menu system; **MENU → UltraGauge Setup.. → Version.** This will display *MPG sensor: MAP, MAF* or *None*

VE RPM (MAP only)

MENU → Vehicle Setup .. → VE RPM (MAP vehicles only)

When Adaptive Volumetric Efficiency is enabled, VE RPM is used to fine-tune VE for your vehicle. Input the RPM at which your vehicle's torque peaks. Typically presented in the form XXX ft-lbs @ RPM, this parameter is commonly specified for most engines and can be found on automotive sites such as vehix.com. Search for your specific vehicle and then find the engine specifications section.

By default this value is set to 4400 RPMs. This value is ignored for MAF vehicles and when Adaptive Volumetric Efficiency is disabled. VE may be monitored through the VE gauge. This gauge is only visible for vehicles with MAP sensors..

If after calibration, it is found that the MPG results are still not accurate enough, the VE RPM value can be further adjusted. If UltraGauge reports less fuel used than actual, reduce the VE RPM by 200 and repeat Calibration. Likewise, if UltraGauge reports more fuel used than actual, increase the VE RPM by 200. The value is arbitrary and experimentation is necessary.

More ..

Set HP1 Max Torque

MENU → Vehicle Setup .. → More .. → Set HP1 Max Torque

Sets the maximum engine torque for the target vehicle. This parameter must first be configured prior to using HP1, KW1 or Torque 1 gauges. The maximum torque is a common parameter that can be found by searching the internet for the engine specification for your vehicle. The torque is commonly specified as a Torque @ a particular RPM. For example, 200 ft.lbs @ 3200 RPM. The torque may be entered in Foot-Pounds (ft.lbs) or Newton Meters (Nm).

Set HP2 Efficiency

MENU → Vehicle Setup .. → More .. → Set HP2 Efficiency

Sets the estimated operating efficiency of the engine. This parameter can be set before using the HP2, KW2 or Torque2 gauges. Horsepower 2, Kilowatts 2 and Torque 2 are derived based on the amount of energy being consumed by the engine and the engine's efficiency. By default the efficiency is assumed to be 24%. This means that only 24% of the energy contained in the fuel actually produces power or torque output. 24% is a good average for typical modern vehicles. This value can be adjusted if more specific information is available.

Force Protocol

MENU → Vehicle Setup .. → Force Protocol

Prevents UltraGauge from searching for the protocol used by the Vehicles Electronic Control Module (ECM). Normally UltraGauge tries each of the five interfaces and protocols until it discovers the protocol used by the ECM. Each vehicle should only support a single protocol. After the initial Scan, UltraGauge will not Scan the interface for the protocol again unless UltraGauge is unplugged.



The Scanning process can interfere with proprietary implementations of the OBD II connector/interface. For example, on some vehicles the traction control light becomes lit, or the speedometer or other gauges may stop functioning, the transmission may shift hard or not at all, or the check engine light may become lit. To avoid these issues, the Protocol can be fixed to that used by the vehicle.

Force Protocol	Description
Auto Discovery	Scans the interface for the protocol. This is the default setting
Force J1850-VPM	Early GM vehicles and some Chrysler vehicles
Force 9141	Most early foreign vehicles and most early Chrysler vehicles
Force Ford	Exclusively used on early ford vehicles.
Force KWP2000	This rare protocol is used on various vehicles.
Force CAN	Used on all 2008 and newer vehicles as well as on many 2004 and newer vehicles.
Force Current	Forces the Protocol currently in use, found during the scanning process. Use this if you can't remember the protocol found.

UltraGauge Automatically remembers the last found protocol and attempts to communicate with the vehicle's ECM using that protocol. As long as communication is established, UltraGauge will not attempt other protocols. If communication is not established, then UltraGauge will cycle though each protocol until communication is established. Forcing the protocol will prevent this and UltraGauge will repeatedly try only the forced protocol.

Once any of the above Forced Protocol menu items are selected, UltraGauge will restart and then communicate with the ECM using only the forced protocol.

If your vehicle is experiencing issues, follow this procedure:

1. Force the protocol: MENU → Vehicle Setup → Force Protocol
2. Unplug UltraGauge
3. Start the vehicle
4. Insure the issue is not present, if present turn of the vehicle and repeat step 3.
5. turn off the vehicle
6. Place the ignition in the RUN position
7. Re-attach UltraGauge. UltraGauge will then discover the available gauges.
8. Once UltraGauge has found the available gauges, start the vehicle and ensure the issue has been resolved

Once forced, UltraGauge will likely not function if moved to a difference vehicle. This can be resolved one of three ways:

1. Prior to moving UltraGauge to a different vehicle select **MENU → Vehicle Setup .. → Force Protocol → Auto Discovery**
2. If the protocol used on the second vehicle is known, use the Force Protocol menu to force the protocol to that of the second vehicle.
3. Once attached to the second vehicle and during the initial scanning screen, hold the **MENU** key until the Menu screen appears. Select **MENU → Vehicle Setup .. → Force Protocol → Auto Discovery**

UltraGauge Setup..

Version

MENU → UltraGauge Setup .. → Version

Displays the following information:

- Version number
- Version date
- Number of Gauges found during the discovery process
- Fuel level Sensor supported; *Yes* or *No*.
- Sensor used to calculate fuel usage and MPG; *MAP, MAF, None, MAP Forced, MAF Forced*. See Force MPG sensor for meaning of “Forced”
- Protocol found during the scanning process

UltraGauge comes with free minor updates for one year. However, it is necessary to ship your unit in for the update, as it is not field updateable. Update information, if any, will be posted on the support page of the Ultra-Gauge.com website. All transportation costs are the responsibility of the user.

Save and Restart

MENU → UltraGauge Setup .. → Save and Restart

Saves any current accumulated MPG, MPH, Time and Distance data and then restarts. Normally this should not be used. However if it is suspected that UltraGauge is not performing correctly, this may correct potential issues.

Restore ALL Defaults

MENU → UltraGauge Setup .. → Restore ALL defaults

Restores all internal and configurable settings back to the factory defaults. Restoring all defaults should be used with care as it restores all configuration such as Calibration, Gauge selection, Alarms settings, display settings as well as all accumulated MPG, MPH, Time, and Distance. This function is a global restore. There is generally individual restores or resets for various functions which should always be used first to correct suspected issues. This can be considered the “Reset” of UltraGauge.

Factory Test

MENU → UltraGauge Setup .. → Factory Test

Used to test UltraGauge at the factory and should normally not be used. It is also used as part of the rebate process. The factory test will print a series of two digit numbers to the screen. The numbers have no practical meaning and are used by factory personnel to establish the validity of the rebate claim. Should the numbers displayed fill and scroll off the screen, power cycle UltraGauge and when prompted select “Safe” mode and then re-run factory test.

Compatibility ..

Power on Detect mode

MENU → UltraGauge Setup .. → Compatibility .. → Pwr on Detect Mode

For compatibility reasons, UltraGauge supports two modes to detect that the ignition is in the RUN position (power on). Normally when UltraGauge detects the power-on condition, UltraGauge exits its low power mode and enables the LCD and the Backlight and begins normal operation.

- **Mode 1:** Mode 1 will always detect correctly, but uses more power while the vehicle is off. This mode should only be used if Mode 2 fails detection.
- **Mode 2:** Mode 2 is the recommended mode and uses less power while the vehicle is off. Mode 2 is the factory default. Mode 2 is ignored for vehicles with 9141 and KWP2000 protocol.

NOTE: If the ignition is placed in the RUN position and UltraGauge fails to exit low power mode, pressing UP will exit the low power mode. If the ignition is off, pressing UP, will cause it to exit the low power mode and then immediately reenter low power mode. (Note, on some versions, use the MENU key for this function instead of the UP key.)

Warning: Setting the “Power on Detect mode” to mode 1 may cause some vehicles to experience battery drain. This is a common problem for 2000-2006 GM vehicles.

Power on Detect delay

MENU → UltraGauge Setup .. → Compatibility .. → Pwr on Detect Delay

Sets the time from when the ignition is switched off until when UltraGauge begins monitoring the communication bus in order to sense when the ignition is again in the RUN position. Normally the default value of 6 seconds is best. However, if there are devices on the bus which continue to be active after the ignition has been turned off; this activity can potentially cause other devices to remain active. Active devices consume more power and represent a drain on the battery. By adding a bus delay time that corresponds to the time greater than when the last device finally becomes inactive, the bus can be assured to be in a low-power state.

If there is a suspicion that modules on the bus are remaining active, and thus causing a drain on the battery, increase this time to several minutes to see if the battery drain stops. If this does stop the drain, reduce the time to the smallest value possible that achieves the same results.

This Bus delay time also has the negative side effect that if the ignition is switched off and then back to RUN quickly, UltraGauge will not detect the RUN position until the Bus delay time has expired.

NOTE: The issue of active devices after ignition OFF, is common to early 2000-2005 GM and Mini Cooper vehicles.

Power off Detect mode

MENU → UltraGauge Setup .. → Compatibility .. → Pwr off Detect mode

For most vehicles UltraGauge will correctly detect when the ignition has been switched to OFF. Should UltraGauge remain on beyond 15 seconds after exiting the vehicle, use this setting to change the method UltraGauge uses to detect that the ignition is in the OFF position.

There are five Power off Detect modes; 0,1,2,3 &4. Mode 0 is the factory default. If when set to mode 4, there are no resulting operation issues, mode 4 is typically preferred. In general the order of mode preference is 4, 2, 1, 0, 3.

If Power-off/ignition-off detection is failing, change the mode value until UltraGauge can successfully sense that the ignition is OFF. Mode 3 is designed to detect ignition OFF on any vehicle. However, mode 3 has the side effect that UltraGauge will not exit power-down mode, unless the engine is running. This means that configuration changes must be made while the engine is idling. Never make configuration changes while driving.

If after increasing the mode UltraGauge will not power on, please follow this procedure:

- Unplug UltraGauge
- Turn the ignition to the RUN position
- Press and hold the Menu key
- Plug in UltraGauge

This will allow access to the configuration menu. Once in the menu, select a different mode.

Exit the Menu.

Power off retries

MENU → UltraGauge Setup .. → Compatibility .. → Pwr off retries

By default UltraGauge will power-down if the vehicle’s ECM does not respond after 3 communication attempts. A non responsive ECM is indicative of the ignition being in the Off position. This setting allows the number of failed communication attempts to be set from 2-99. Normally a value of 3 is best and preferred. If UltraGauge at times enters low power mode and briefly turns off the display while the ignition is in the RUN position, increase the number of retries until the behavior stops. The side effect of increasing the value is that UltraGauge will remain on for a longer period of time after the ignition is switched to Off. Hence, a smaller value is best.

Changing this setting is not recommended for vehicles with KWP 2000 or 9141 protocols.

This configuration setting was primarily added for Smart Cars which experience a false ignition off detection roughly every 30 minutes.

KWP/9141 Optimize

MENU → UltraGauge Setup .. → Compatibility .. → KWP/9141 Optimize

The 9141 and KWP2000 protocols are very inefficient. The more engine specific gauges displayed on a page, the slower the page will update. This can be witnessed by watching the health indicator beat rate. For all other protocols, the health indicator beats about once each second. With 9141 and KWP 2000 the update rate can be as long as 2.2 seconds. With this setting, the update rate for some 9141/KWP vehicles may be improved. By default the value of this setting is 100, which corresponds to the most compatible setting. As this value is reduced KWP/9141 performance and the display refresh rate increase. Some vehicles function without issue with a setting of 1, while others require the slowest setting of 100.

When this menu item is selected, the KWP/9141 Optimizer starts. The Optimizer will determine the optimal setting for the particular vehicle. When complete the optimal value is displayed. The value can be accepted by pressing “MENU”, or it can be manually overridden by entering a new value using the UP/DOWN keys. A value less than the Optimizer value should never be manually entered.

It is recommended to run the optimizer a few times, and then use the resulting largest value.

For some vehicles manually setting the value too low will actually result in potentially anomalous behavior, such as:

- Slower update rate
- “Err” seen occasionally for various gauge values.
- “Comm Lost, restarting” message during initial gauge discovery

1. This is an optional setting and should only be used if you are dissatisfied with the update rate

NOTE: The ignition must remain in the RUN position. The engine should be off.

NOTE: This setting is applicable to ONLY vehicles with the 9141 or KWP 2000 Protocol; it has no affect upon other protocols.

NOTE: As an alternative, the update rate can also be increased by reducing the number of “engine specific” gauges on any given page. Setting the “Pwr off Detect mode” to a value other than 0, may also increase KWP/9141 performance.

NOTE: If UltraGauge is moved to another KWP/9141 vehicle, it will be necessary to run the optimizer on the new vehicle. It is advisable that the value be set to 100 prior to moving UltraGauge to the new KWP/9141 vehicle.

NOTE: If manually setting this value results in UltraGauge not functioning, follow this procedure to restore UltraGauge

- Unplug UltraGauge
- Press and hold the Menu Key
- Plug in UltraGauge
- Holding the Menu key will cause the menu to appear.
- Return to the update rate and set it back to a known good value.

Force MPG Sensor

MENU → UltraGauge Setup .. → Compatibility .. → Force MPG Sensor

Forces UltraGauge to use the MAF or MAP sensor to calculate fuel usage.

Force MPG Sensor Setting	Description
Auto	UltraGauge automatically determines the best sensor to use
MAP	UltraGauge is forced to use the MAP sensor
MAF	UltraGauge is forced to use the MAF sensor.

Normally **Auto** is the correct and desirable setting. Certain vehicles misreport the presence of a sensor. When this happens, UltraGauge is not able to calculate the fuel usage and various mileage gauges may display “Err” or nonsensical values. All other gauges display correctly. This setting is used to override the reported sensor presence and forces UltraGauge to use the selected sensor. This problem is common on F250 and F350 Ford diesel trucks. Typically the presence of MAF is reported when it is not present. In this situation, setting Force MPG Sensor to “**MAP**” will resolve the issue.

Injector Cutoff

MENU → *UltraGauge Setup* .. → *Injector Cutoff*

Often the engine is used to de-accelerate the vehicle, for example when heading down hill in gear or when the engine is used to slow the vehicle during engine braking. While in gear and during de-acceleration, many vehicle manufacturers will turn off the fuel injectors in order to save fuel. This is true for vehicles with either manual or automatic transmissions. The fuel savings is slight, but over time and distance could become significant. UltraGauge can detect when the injectors are switched off and factor the fuel savings into the fuel usage and mileage calculations.

Injector cutoff is disabled when set to zero, and is disabled by default. To enable Injector cutoff detection, set the value equal to seven times the engine size in liters, rounded up to a whole number. For example, for a 2.3L engine the value should be set to $2.3 \times 7 = 16.1 \rightarrow 17$. The value is not crucial and this calculation represents a best estimate.

When enabled and injector cutoff occurs, the Instantaneous MPG will read 999.9, and the Instantaneous Gallons/hour will read 0.0

Injector Cutoff should only be seen when de-accelerating. If during heavy acceleration, Injector Cutoff falsely occurs, decrease the injector cutoff value by 20% or until cutoff no longer occurs. Setting the value too low will cause the Injector Cutoff never to be detected.

NOTE: Injector cutoff detection should be enabled prior to performing fuel calibration. If enabled after calibration, the calibration procedure should again be performed.

NOTE: If the open/closed loop indicator is not displayed on the gauge display or the loop is always open, then the vehicle does not support Injector Cutoff detection and this feature should remain disabled. If the loop indicator is always open, this could indicate an issue with your vehicle. If so, check for the presence of trouble codes.

NOTE: Each vehicle manufacturer has their own algorithm for injector cutoff. Some require significant de-acceleration, usually detected in terms of higher RPMs and a certain speed threshold, while others have a much lower de-acceleration requirement.

NOTE: When the transmission is placed in neutral, the vehicle's injector cutoff function is disabled.

NOTE: This is an optional setting and provides only marginal benefit to fuel usage and MPG calculations.

DISPLAY SETTINGS..

SET Backlite Mode

MENU → Display Settings .. → Set Backlite Mode

Backlight Mode	Description
Fixed	Backlight is fixed to a set brightness. The brightness level is set via the BackliteMaxBright menu item
Automatic	The Backlight is automatically controlled

Fixed:

When the Backlight Mode is set to Fixed, the backlight level is fixed to the level set by MENU → Display Settings .. → **Backlite Max Bright**.

Automatic:

When set to **Automatic**, the backlight brightness is automatically varied according to the vehicle's inside cabin ambient light level. UltraGauge's backlight brightness increases as ambient light brightness increases. This is useful to maximize brightness and contrast during daylight hours and to minimize brightness during nighttime driving. In Automatic mode, the backlight brightness is limited to a minimum brightness and a maximum brightness, and the backlight is automatically adjusted between these limits. The limits are set via the menu items; **Backlite Min Bright** and **Backlite Max Bright**.

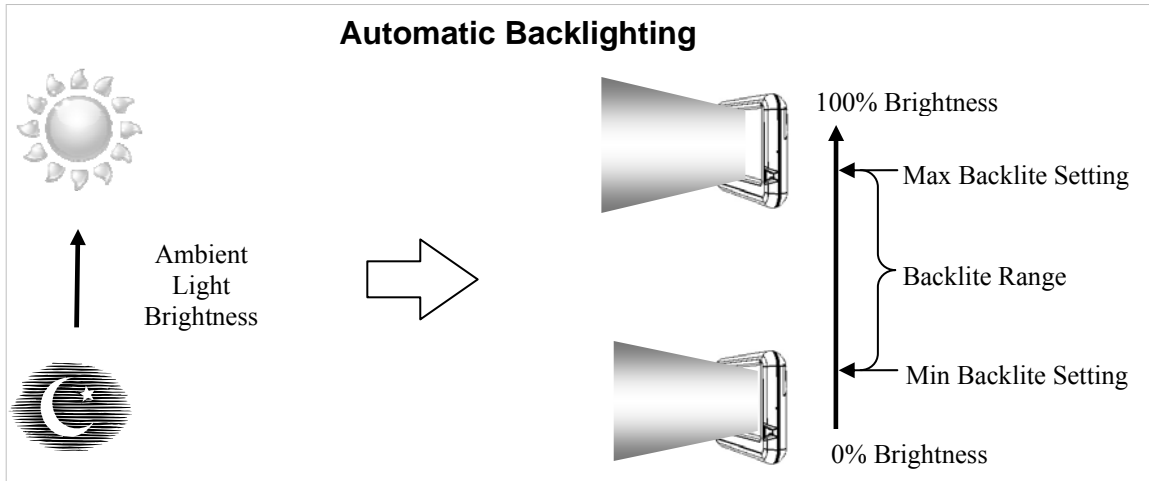

The sensitivity to the Ambient light can be adjusted via the **Ambient Sensitivity** menu setting. This setting allows UltraGauge to better adjust the Backlight brightness depending on the Vehicle's ambient light. For example, vehicles with tinted windows or with smaller windows will have overall lower light levels and an increase in sensitivity would be recommended. See the **Ambient Sensitivity** setting for more detail.

Backlite Min Brightness

MENU → Display Settings .. → Backlite Min Bright

This setting is used in conjunction with the **Backlite mode** setting.

When the Backlite Mode is set to Fixed, this setting has no effect.

When the Backlite Mode is set to Automatic, this setting becomes the Minimum Backlight Level and the brightness is automatically adjusted between Minimum and Maximum light levels according to ambient light levels.

The brightness is set as a percentage of the maximum Backlight level. A value of 100% corresponds to the maximum light level. 0% corresponds to the lowest light level. Note that 0% is not off, but rather the lowest backlight setting that is still visible. Changes are reflected immediately. Avoid covering the sensor window with your thumb while making adjustments.

Backlite Max Brightness

MENU → Display Settings ..→ Backlite Max Bright

This setting is used in conjunction with the **Backlite Mode** setting.

When the Backlite Mode is set to Fixed, this setting directly sets the fixed Backlight Brightness Level.

When the Backlite Mode is set to Automatic, this setting becomes the Maximum Backlight Level and the brightness is automatically adjusted between Minimum and Maximum light levels according to ambient light levels. Changes are reflected immediately. Avoid covering the sensor window with your thumb while making adjustments.

Note:

If the internal temperature should reach 140°F, UltraGauge will automatically dim the display to 65%. The Backlight is responsible for most of the internal heat and reducing the brightness to 65% significantly reduces this heat. Once the temperature falls below 136°F, the display brightness will return to the user configured settings.

Ambient Sensitivity

MENU → Display Settings ..→ Backlite Max Bright

When the Backlite Mode is set to Automatic, this setting is used to set UltraGauge's sensitivity to the vehicle's inside cabin ambient light level. Vehicles with tinted, smaller or fewer windows will have lesser ambient light levels. This setting allows UltraGauge to be tailored to your vehicle's light levels. This setting has a range of from 0-100, with 100 being the most sensitive. As the sensitivity is increased, UltraGauge becomes more responsive to lower light levels. At a setting of 0, UltraGauge must capture significant light before it begins to increase the Backlite level. At a setting of 100, a very insignificant amount of light causes UltraGauge to increase Backlight Levels.

Since this setting is very relative, it must be adjusted experimentally for your vehicle. While using UltraGauge, if the Maximum backlight brightness is not achieved in ambient light that you believe should produce Maximum Backlight brightness, increase the sensitivity by 5 and watch the results. Repeat until satisfied. Changes are reflected immediately.

Note: On the front right hand side of UltraGauge there is an opening which UltraGauge uses to capture ambient light. Avoid covering the sensor window with your thumb while making adjustments.

Note: If the sensitivity is set to high, the UltraGauge will be too bright for nighttime driving.

Adjust LCD Contrast

MENU → Display Settings ..→ Adjust LCD Contrast

Use this menu item to fine tune the contrast of the display. Ideal contrast is achieved when the text brightness is maximized and the background brightness is minimized. Changes to the contrast setting are instantly updated on the display. Once the ideal contrast is reached, press Menu to exit.

ALARMS..

Alarms can be set for every gauge. Alarms may also be optionally enabled for newly posted trouble codes and pending trouble codes. Each gauge can have a high and low alarm. Each Low and High Alarm can individually be enabled and the value of each high and low alarm threshold can be individually set. UltraGauge continually compares real-time gauge values to each of the alarm values. If the real-time value is greater than the high alarm or less than the low alarm, an alarm is initiated. The Alarm is both audible and visual. The audible portion of the alarm may be disabled if so desired. Alarms as a whole can also be disabled. During an alarm, the alarm may be suspended by pressing the DOWN key. Once suspended, the alarm for that specific gauge will no longer trigger. However, the suspended alarm will be again be enabled when the ignition is switched from RUN to OFF.

Set Gauge Alarms ..

MENU → Alarms .. → Set Gauge Alarms ..

Each Gauge has both a Min and Max Alarm. For example, a temperature gauge has both a high temperature alarm and a low temperature alarm. Whenever the alarm value is exceeded the alarms sounds. Each alarm can be individually enable or disabled and the value for that alarm can be set. By default many of the alarms are enabled and factory default values are set. On the last row of each alarm is a value that represents the extreme limits for that particular gauge.

To set or enable an alarm:

1. select *MENU* → Alarms .. → Set Gauge Alarms ..
2. Use the **UP** & **DOWN** keys to Navigate to the desired Gauge. Press **Next** or **Back** to advance to the next group of gauges
3. While the cursor is positioned next to the desired gauge, Press **MENU**. This will show the alarm screen for that gauge, as shown below.
4. Pressing **UP** or **DOWN** will cause the cursor to move around the alarm window.
5. While positioned over the off/on selection for the Alarm, pressing **MENU** will toggle the alarm from on to off and off to on.
6. While positioned over the Value field, pressing **MENU** will cause the cursor to blink, signifying data entry mode. Use the **UP** and **DOWN** keys to advance the value to the desired value. The Alarm will only trigger when the measured value exceeds the trigger value. Note that the value will always be just short, by the least significant digit, of the maximum value, since if the max value was set, the alarm would never trigger. Press **MENU** to finalize the setting
7. Select **BACK** to exit the alarm menu for the particular gauge

All settings are saved as they are made. The UltraGauge configuration is stored in non-volatile memory so that it is preserved through vehicle start/stop cycles or unplugging of the unit. The configuration remains until the user chooses to change it.

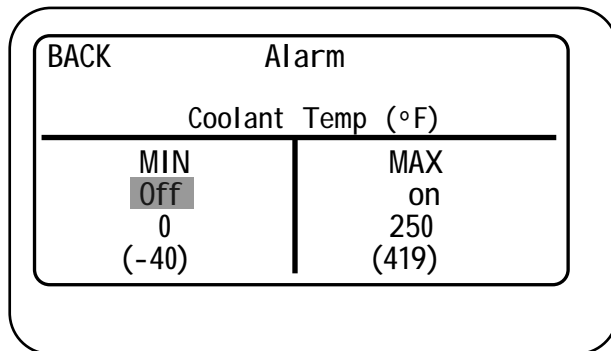

Alarm siren on/off

MENU → Alarms .. → Alarm siren on/off

Allows the audible alarm siren to be switched on or off. This only affects the audible siren and does not affect the visible siren. This does not affect key press tones.

All alarms on/off

MENU → Alarms .. → All Alarms on/off

Globally enables or disables all Gauge Alarms both audible and visual.

Alarm siren freq

MENU → Alarms .. → Alarm Siren Freq

Allows the frequency of the alarm siren to be adjusted. By default the frequency of the siren is set to 4450 Hz. This typically represents the optimal frequency for maximizing volume and clarity. The frequency can be adjusted from 3000-5000Hz. Set the frequency to a value that is best suited for your hearing.

Load Default Alarms

MENU → Alarms .. → Load Default Alarms

Restores all gauge alarm settings back to the factory defaults.

Table 2 - Alarm Factory Defaults

Min Alarm on/off	Min Alarm Value	Max Alarm on/off	Max Alarm Value	Gauge
off	0	off	70	% Engine Load
off	0	on	250	Engine Coolant Temperature (°F)
off	0	off	120	Engine Coolant Temperature (°C)
off	0	off	0	Short Term Fuel Trim Bank 1
off	10	off	10	Long Term Fuel Trim Bank 1
off	0	off	0	Short Term Fuel Trim Bank 2
off	10	off	10	Long Term Fuel Trim Bank 2
off	0	off	50	Fuel Pressure (PSI)
off	0	off	345	Fuel Pressure (kPa)
off	0	off	10	Intake Manifold Absolute Pressure (PSI)
off	0	off	69	Intake Manifold Absolute Pressure (kPa)
off	0	on	4000	RPM
off	0	on	90	MPH
off	0	off	145	KPH
off	-30	off	30	Timing Advance
off	0	on	210	Intake Air Temperature (°F)
off	0	off	99	Intake Air Temperature (°C)
off	0	off	400	Mass Air Flow Sensor 1 (g/s)
off	0	off	0	Absolute Throttle Position 1 %
off	0	off	0	Bank 1 Oxygen Sensor 1 Voltage
off	0	off	0	Bank 1 Oxygen Sensor 2 Voltage
off	0	off	0	Bank 2 Oxygen Sensor 1 Voltage
off	0	off	0	Bank 2 Oxygen Sensor 2 Voltage
off	0	off	500	Miles traveled with Check Engine Light On.
off	0	off	800	Kilometers traveled with Check Engine Light On.
off	0	off	1000	Fuel Pressure (Diesel) (PSI)
off	0	off	690	Fuel Pressure (Diesel) (10kPa)
off	0	off	1.8	Bank 1 Wide Oxygen Sensor 1 Lambda
off	0	off	1.8	Bank 2 Wide Oxygen Sensor 1 Lambda
off	0	off	95	EGR Flow %
off	0	off	20	EGR Flow % Error
off	0	off	0	Evaporative Purge %
off	0.1	off	0	Fuel Level % of full
off	0	off	0	Number of Warm-ups since Check Engine Light Cleared
off	0	off	50	Miles traveled since Check Engine Light Cleared
off	0	off	800	Kilometers traveled since Check Engine Light Cleared
off	-1	off	1	Evaporative System (PSI)
off	-6000	off	6000	Evaporative System (Pa)
off	29	off	30.5	Barometric Pressure – Inches of Mercury (inHg)
off	98.2	off	103.2	Barometric Pressure – Inches of Mercury (Pa)
off	0	on	2011	Catalytic Converter Bank 1 Sensor 1 Temperature (°F)
off	0	off	1100	Catalytic Converter Bank 1 Sensor 1 Temperature (°C)
off	0	on	2021	Catalytic Converter Bank 2 Sensor 1 Temperature (°F)
off	0	off	1105	Catalytic Converter Bank 2 Sensor 1 Temperature (°C)
off	0	on	2012	Catalytic Converter Bank 1 Sensor 2 Temperature (°F)
off	0	off	1100	Catalytic Converter Bank 1 Sensor 2 Temperature (°C)
off	0	on	2022	Catalytic Converter Bank 2 Sensor 2 Temperature (°F)
off	0	off	1106	Catalytic Converter Bank 2 Sensor 2 Temperature (°C)
off	0	on	14.9	Battery Voltage
off	0	off	90	Load abs%
off	.25	off	1.75	AFR commanded ratio
off	0	off	90	Relative Throttle Position %
on	-10	on	115	Outside Ambient Air Temperature (°F)
on	-23	off	46	Outside Ambient Air Temperature (°C)
off	0	off	90	Absolute Throttle Position 2 %
off	0	off	90	Accelerator Pedal Position 1 %
off	0	off	90	Accelerator Pedal Position 2 %
off	0	off	90	Command Throttle Position %
off	0	off	10	Boost PSI
off	0	off	69	Boost kPa
off	0	off	400	HP1
off	0	off	400	KW1
off	0	off	450	TRQ1 ftlbs
off	0	off	450	TRQ1 Nm
off	0	off	400	HP2

off	0	off	400	KW2
off	0	off	450	TRQ2 ftlbs
off	0	off	450	TRQ2 Nm
off	0	off	1	Mass Air Flow Sensor 2 – Calculated
off	0	off	200	Instantaneous MPG
off	0	off	70	Instantaneous KPL
off	0	off	51	Instantaneous L/100km
off	0	off	60	Average MPG – General
off	0	off	26	Average KPL – General
off	0	off	51	Average L/100km – General
off	0	off	70	Average MPH – General
off	0	off	113	Average KPH – General
off	0	off	5	Average G/H -- General
off	0	off	19	Average L/H -- General
off	0	off	500	Run Time - General
off	0	off	10,000	Miles – General
off	0	off	16,093	Kilometers – General
off	0	off	500	Gallons Used – General
off	0	off	1893	Liters Used – General
off	0	off	5	Instantaneous Gallons/Hour
off	0	off	19	Instantaneous Liters/Hour
on	1	off	0	Fuel Level (Gallons)
off	3.8	off	0	Fuel Level (Liters)
on	20	off	0	Miles to Empty
off	32	off	0	Kilometers to Empty
off	0.1	off	0	Time to Empty (miles)
off	1	off	99	Volumetric Efficiency (Map vehicles only)
off	0	off	70	Trip Average MPH
off	0	off	113	Trip Average KPH
off	0	off	70	Trip Average MPG
off	0	off	113	Trip Average KPL
off	0	off	51	Trip Average L/100km
off	0	off	100	Trip Gallons Used
off	0	off	379	Trip Liters Used
off	0	off	4	Trip Ave Gallons/Hour
off	0	off	15	Trip Ave Liters/Hour
off	0	off	10	Trip Run Time (Hours:Minutes)
off	0	off	1000	Trip Miles
off	0	off	1610	Trip Kilometers
off	0	off	70	Srt Trip Average MPH
off	0	off	113	Srt Trip Average KPH
off	0	off	60	Srt Trip Average MPG
off	0	off	21	Srt Trip Average KPL
off	0	off	51	Srt Trip Average L/100km
off	0	off	100	Srt Trip Gallons Used
off	0	off	379	Srt Trip Liters Used
off	0	off	4	Srt Trip Ave Gallons/Hour
off	0	off	15	Srt Trip Ave Liters/Hour
off	0	off	20	Srt Trip Run Time (Hours:Minutes)
off	0	off	1000	Srt Trip Miles
off	0	off	1610	Srt Trip Kilometers
off	0	on	3,000	Oil Miles
off	0	off	4,828	Oil Kilometers
off	0	on	30,000	Service Miles
off	0	off	48,280	Service Kilometers
off	0	on	145	UltraGauge Internal Temperature (°F)
off	0	off	63	UltraGauge Internal Temperature (°C)

Note! The more alarms enabled, the longer it takes UltraGauge to detect if a particular alarm has been triggered. If it is critical that a particular alarm generate an alert quickly, then disable other unimportant alarms.

Trouble Code Alarm

MENU → Alarms .. → Trouble Code Alarm

Enabling this alarm will cause UltraGauge to alarm if trouble codes are posted by the Vehicles ECM. Most likely the vehicles Check Engine Light on the dash will also light. To view the posted trouble codes select **MENU → Trouble Codes.. → Engine Trouble Codes.** UltraGauge checks for trouble codes every other time it completes checking all other gauge alarms.

Pending TC Alarm

MENU → Alarms .. → Pending TC Alarm

Enabling this alarm will cause UltraGauge to alarm if pending trouble codes are posted by the Vehicles ECM. The Vehicle will not light the Check Engine Light on the dash when pending codes are posted. To view the posted pending trouble codes select **MENU → Trouble Codes.. → Pending Codes.** UltraGauge checks for pending trouble codes every other time it completes checking all other gauge alarms.

Trouble Codes ..

In order to read or clear the trouble codes, the engine does not need to be running, but the ignition must be in the RUN position and it must stay in this position.

Clear Check Engine

MENU → Trouble Codes .. → Clear Check Engine

This not only turns off the check engine light, it also clears all the Trouble Codes posted by the vehicles ECM. Note that if the trouble code was associated with a hard fault, such as a shorted sensor, the vehicle's ECM will quickly repost the trouble code to pending codes, or in some cases directly to the trouble codes and again light the check engine light. In this situation, it may appear that the check engine light remains lit.

Note:

Some vehicles may not support this function. Vehicles supporting the VPM protocol such as older GM vehicles and some older Chrysler vehicles have been found not to support this function.

Engine Trouble Codes

MENU → Trouble Codes .. → Engine Trouble Codes

Displays any trouble code as well as the number of trouble codes. UltraGauge can display up to 20 codes. Each trouble code is prefixed by a letter. The letters signify the following:

Trouble Code Prefix Letter	Meaning
P	Power Train
C	Chassis
B	Body
U	Undefined

The four numeric digits following the letter prefix uniquely identify the code for your vehicle. Each manufacturer may choose to define codes differently and even differently among vehicle models.

The best approach to decode a trouble code is to search the web. For example, search for "2004 Dodge Durango P1002 Trouble code". There are several sites dedicated to providing trouble code information. Here are a few sample sites:

http://www.obd-codes.com/trouble_codes

<http://www.trouble-codes.com>

<http://www.troublecodes.net/technical>

http://autorepair.about.com/od/obdcodedatabase/a/OBD_1996_year.htm

Pending Codes

MENU → Trouble Codes .. → Pending Codes

Displays any pending trouble codes as well as the number of pending trouble codes. UltraGauge can display up to 20 pending codes. Pending codes are potential issues discovered by the Vehicle's ECM. These discovered issues are placed in the pending category and watched by the ECM. If the issue persists after a certain amount of time or after a certain number of starts, the ECM will move the code from Pending to the Trouble Code category, at which point the check engine light would be lit.

The format and meaning of Pending Codes is the same as that for Trouble Codes. See Engine Trouble Codes for additional detail.

Miscellaneous

Units of Measure

Most of the gauges displayed by UltraGauge do not indicate the units of measure used. All units are those most commonly used in the United States. There is no means to change the units of measure used or displayed by UltraGauge, rather select a gauge with the desired units. The following are used unless specifically indicated otherwise for a particular gauge.

Measure	Unit
Distance	Miles or Kilometers
Temperature	Fahrenheit or Celsius
Pressure	PSI or kPa
Angle	Degrees
Volume	Gallons or Liters

Using UltraGauge on more than one vehicle.

Although not recommended, UltraGauge can be used on more than one vehicle. UltraGauge stores information such as engine size, fuel tank size, mileage, distance, calibration and other configuration settings specific to your vehicle. Before use on a second vehicle, UltraGauge will need to be completely reconfigured and calibrated. However, UltraGauge can be used to check engine trouble codes on another vehicle without configuration or calibration.

Cleaning

The UltraGauge display uses a high quality glass with no coatings. Clean the glass as you would the lens of sunglasses. Exhale slowly and deeply onto the display. This will cause moisture to condense on to the glass. Wipe the display with a soft cloth.

If simple moisture is not enough to clean the display, spray a small spot of glass cleaner on to one end of a paper towel, tissue paper or soft cloth. Never directly spray window cleaner onto the display. Wipe the display with the area of the paper towel containing the spot of window cleaner. Once clean, use the other end of the paper towel to dry the display.

If glass cleaner does not clean the glass, use Goo Gone or other citrus based cleaner.

<http://www.magicamerican.com/googone/product/c7f8659a-40a3-412c-9f1c-03108e6a30db.aspx>

The body of UltraGauge is formed from a durable plastic that is designed to reduce finger print marks and generally needs no cleaning. However, the body may be cleaned using the same procedure as described for cleaning the display glass.

Frequently Asked Questions

1. *Does UG consume power when vehicle is off?* Yes, UG is always on, but is using very little power when the vehicle is off
2. *How much power does UG consume?* 1W or 1/60th of a 60watt light bulb when the display is active, less than 1/4W when the display is off
3. *How accurate are Gauge readings?* For most Gauges, the values displayed are taken unaltered from your vehicles sensors and displayed. The accuracy is ultimately determined by your vehicles sensors. UG Gauges are typically much more accurate than the vehicle's dash analog gauges.
4. *How accurate is the MPG Gauge?* In general, the MPG reported should only be used for relative mileage, and should not be relied upon for absolute MPG. MPG is one of the few Gauges which must be calculated from several vehicle sensors. For vehicles with Mass Air Flow (MAF) Sensors, the MPG is determined by combining the MAF and Speed sensors only. Hence MAF equipped vehicles have the highest MPG accuracy. Vehicles without a MAF but rather having a Manifold Air Pressure

(MAP) sensor, use 4 different vehicle sensors and assume that the vehicle is operating correctly. Vehicles with MAP sensor derived MPG are inherently less accurate than MAF. The accuracy of a MAP system is dependent on the accuracy of the sensors involved and fuel used. The use of additives, or fuel containing ethanol, will alter the MPG for both MAP and MAF vehicles. Note that UG has the option to compensate for these factors by allowing the fuel usage to be calibrated. See **MPG calibration** and **Adaptive Volumetric Efficiency** for additional details

5. *Nothing happens when I press Menu, is my UG broken?* Hold **Menu** depressed until the display changes. It should not take longer than 3 seconds. Also, UG will not respond to the menu button while it is discovering gauges. It will respond before and after discovery
6. *Will UG show all Trouble Codes?* UG will display the first 20 error codes.
7. *What is a Pending Trouble Code?* Often trouble codes are not reported by the vehicle unless the trouble is seen over several driving cycles. Pending trouble codes are those that have been detected but have yet to be seen over multiple driving cycles.
8. *Does my vehicle use MAF or MAP?* This is displayed in the menu; **MENU → UltraGauge Setup.. → Version**
9. *How many gauges are available for my Vehicle?* UG will automatically discover all the available gauges for your vehicle. All gauges found will be listed under "Gauges" in the menu system. The number and type of gauges supported varies among vehicle models and manufacturers. Some support many gauges while others support very few. There is no way to know in advance. The discovery process provides a definitive answer.
10. *Why doesn't UG show a MPG Gauge in the Gauge selection Menu?* When UG discovers the gauges available for your vehicle, it determines if the gauges available are those necessary to calculate mileage. If not, the MPG gauges will not appear in the selection Menu. Please report this to support2@Ultra-Gauge.com and include the make and model of your vehicle
11. *Distance Seems off?* UG stops measuring distance when the menu system is used. The menu system should never be used while the vehicle is in motion. See Distance Calibration for more information.
12. *Will alarms not sound when in the menu?* Alarm checking is not active while within the menu.
13. *What is the difference between Oil, Trip and Service Distance?* Each can be individually reset and have different distance values. Oil Distance is meant to act as a reminder of when the oil was last changed. Service is meant to remind you when a service interval has been reached. However, Trip, Oil and Service distance can be used interchangeably. Note that alarms can be set for each. For example, you can set Oil to 3000 miles, and Service to 30,000 miles as a reminder of the next service interval.
14. *Will the Fuel usage and Distances be lost if I unplug UG or disconnect the battery?* No, UG does not need power to retain mileage and distance totals. However, always turn the ignition to off before disconnecting UG.
15. *Will Distance and MPG still continue to be calculated even if neither is a current visible gauge?* Yes, UG always updates Average MPG and Distances in the background.
16. *My UG sometimes starts Scanning unexpectedly, is there a problem?* The Large Connector to which UG attaches sometimes becomes corroded as a result of moisture. Check your vehicle's connector for corrosion. Often an anti-moisture, anti-corrosive grease can be applied to the terminals to halt any further decay. Ask for the electrical contact grease at your local auto parts store. Here is a link to an example product:
http://www.permatex.com/products/Automotive/specialized_maintenance_repair/electrical_system_maintenance/Permatex_Bulb_Lamp_Electrical_Connector_Dielectric_Grease.htm
17. *I disconnected the cable, and my distance and MPG totals are off, is there a problem?* UG saves distance and Average MPG each time the ignition is set from RUN to Off. If the cable is disconnected prior to turning the ignition to off, newly accumulated MPG and distances since the vehicle was started, will be lost. Previous data will not be lost. Always turn off the vehicle before disconnected UG.
18. *Does UG have a reset button?* No, UG should never need resetting. However, the device can be reset by unplugging/plugging the cable, or by executing: **MENU → UltraGauge Setup .. → Save and Restart**
19. *Trouble Codes "Not Supported"?* If your vehicle does not respond to a code read request, this message will be displayed. In some circumstances, returning to the gauge screen and then re-entering the menu system might reset a temporary condition preventing the trouble codes from being accessed. The ignition must be in the RUN position prior to and while in the MENU system. If this problem persists, please create a support ticket
20. *Odd vehicle behavior when UG is attached?* On many 2005-2006 Hyundai's the ESC light or a U0001 trouble code may be reported when UG initially scans the interface. This is the result of Hyundai supporting two different interfaces. One interface is not fully and correctly implemented and reacts to UG's scan by potentially posting U0001 or lighting the ESC indicator on the dash. Use **MENU → Trouble Codes .. → Clear Check Engine** to clear the trouble code. See the **Force Protocol** section for more information. For 2005-2006 Hyundai's the protocol should be 9141 or KWP.
21. *The Fuel Level % Gauge is frozen or dramatically inaccurate, is there a problem?* Your vehicle may be improperly reporting the fuel level sender. Please see the **Level Sender Mode** Menu item for additional information and corrective measures.

Troubleshooting

Can't read trouble codes.

The engine need not be running, but the ignition must be in the RUN position and it must remain in this position. For vehicles with 9141 or KWP2000 protocol: Exit the Menu system. Turn the ignition off. Wait 10 seconds, turn the ignition back to RUN and proceed to the trouble code menu.

Can't clear trouble codes.

The engine need not be running, but the ignition must be in the RUN position and it must remain in this position. Some vehicles such as older vehicles supporting the VPM protocol do not support this function. For vehicles with 9141 or KWP2000 protocol: Exit the Menu system. Turn the ignition off. Wait 10 seconds, turn the ignition back to RUN and proceed to the trouble code menu.

Scanning or Discovery fails

The engine need not be running, but the ignition must be in the RUN position and it must remain in this position during discovery and scanning.

The Cable falls off the OBD II connector.

The vehicle's OBD II connector contains a locking tab designed to capture the OBDII cable connector. If the vehicle's OBDII connector has been damaged such that the locking tab is missing or deformed, the connector may come loose or fall off. One simple fix is to add a rubber band or tie strap around both connectors.

The Gauge sometimes displays "Err".

If UltraGauge requests gauge data from the vehicle's computer, but the vehicle does not provide the data, UltraGauge displays **Err**. This is commonly, and briefly seen when the vehicle's ignition is switched from the RUN to the off position. It is acceptable for **Err** to be displayed very infrequently during normal operation. If **Err** is displayed frequently, say once every 4 seconds, then a problem may exist. Turn the vehicle off and reseal the connector.

UltraGauge will not shut off

UltraGauge will not shutoff automatically while in the menu system. Exit the menu system and UltraGauge will detect that the vehicle's ignition is not in the RUN position and UltraGauge will shut off.

The key is in the run position, yet UltraGauge is dark.

Either UltraGauge is not receiving power or UltraGauge can not communicate with the vehicle's computer.

Try the following measures:

- Reseat the UltraGauge Connector.
- Try UltraGauge in a different vehicle
- The Vehicle's OBD II connector will typically have a 4-20 Amp fuse. Check the fuse.
- Check the Vehicle's OBD II connector for corrosion.
- Has the brightness of the display been turned to its lowest setting and it only appears dark? Could the light sensor opening on the lower right corner of UltraGauge be blocked?
- UltraGauge has its own internal fuse built into the connector. If the cable has been damaged the fuse may have opened. Check the cable for damage. Note that it would take a shorted cable to open the internal fuse. This is unlikely. The internal fuse is not replaceable.

MPG or DTE or Fuel Used not accurate

It is imperative that vehicles with MAP sensor, or that use diesel or natural gas, perform the MPG calibration. Without calibration, MPG and Fuel usage can be off by 30%. See also Adaptive Volumetric efficiency. For DTE, check that the fuel tank size has been set correctly. The fuel tank size is listed in your owners manual.

Some Gauge Zones are blank

Each zone on a page configured for 4 , 6 or 8 gauges can have a gauge assigned or not. A zone that is unassigned will appear empty.

Specifications

Voltage Range	10 to 16 Voltage
Interface	OBD II compliant
Protocols supported	CAN 11-bit, CAN 29-bit, J1850-VPM (GM), J1850-PWM (Ford), ISO 9141 (Chrysler and foreign)
OBD II cable length	~ 6 foot
Operating temperature Range	0 °F to 160 °F
Display	LCD, LED backlight, Thermally compensated
Dimensions	3.43" Wide x 2.14" Height x 0.50" Depth
Power	~1W with display active, less than 1/4 watt with display off

Document Revision History

Doc Revision	Date	Detail
1.0	8/1/11	First document release
1.1	9/19/11	Corrected typo of K/100L → should be L/100k

OBDII Compliancy decals

Every passenger vehicle or light truck sold in the USA since 1996 has been federally required to be OBD II compliant. Compliance is indicated on the emission decal located under the hood. The decal is a black and white adhesive label, and can be found on the sill just before the radiator, on the under side of the hood, on the firewall, on the fender skirt, or just about any area under the hood that is somewhat flat and easily viewed. The following are just a few examples of emissions decals bearing the OBDII certification.

VEHICLE EMISSION CONTROL INFORMATION		
ENGINE FAMILY	EFN 2.8VBT2EA	OBDII CERTIFIED
DISPLACEMENT	2.8L	
THIS VEHICLE CONFORMS TO U.S. EPA AND STATE OF CALIFORNIA REGULATIONS APPLICABLE TO 1997 MODEL YEAR NEW TLEV PASSENGER CARS		
REFER TO SERVICE MANUAL FOR ADDITIONAL INFORMATION TUNE UP CONDITIONS: NORMAL OPERATING ENGINE TEMPERATURE, ACCESSORIES OFF, COOLING FAN OFF, TRANSMISSION IN NEUTRAL		
EXHAUST EMISSIONS STANDARDS	STANDARD CATEGORY	
CERTIFICATION	TLEV	
IN USE	TLEV INTERMEDIATE	
SPARK PLUG TYPE NGK BFRES-1P GAP 1.1mm	CATALYST	EFN 2.8VBT2EA

IMPORTANT VEHICLE INFORMATION	
THIS VEHICLE CONFORMS TO U.S. EPA NLEV AND CLEAN-FUEL VEHICLE AND CALIFORNIA REGULATIONS APPLICABLE TO GASOLINE FUELED 1999 MODEL YEAR NEW LEV LIGHT DUTY TRUCKS. CERTIFICATION TEST FUEL: EPA UNLEADED GASOLINE	ENGINE DIAGRAM
VEHICLE LASH (N)0.22±0.02mm (COLD) (E)0.30±0.02mm SPARK PLUG GAP 1.0-1.1mm IDLE SPEED 730±50rpm	
TUNE UP CONDITION: ENGINE AT NORMAL OPERATING TEMPERATURE, ALL ACCESSORIES TURNED OFF, COOLING FAN OFF, TRANSMISSION IN NEUTRAL, NO OTHER ADJUSTMENTS NEEDED.	CATALYST
EFN	
352HGGGG	5 • P

CATALYST	DaimlerChrysler Corporation	5274865AA
	VEHICLE EMISSION CONTROL INFORMATION	
	THIS VEHICLE CONFORMS TO U.S. EPA NLEV REGULATIONS AND CALIFORNIA REGULATIONS APPLICABLE TO 2003 MODEL YEAR NEW LEV PASSENGER CARS, AND CLEAN FUEL FLEET VEHICLE REGULATIONS. CERTIFICATION GASOLINE FUEL PER 86.113-94a. SFTP COMPLIANT	
		TWC, HO2S(2), SFI OBDII CERTIFIED