

# Service Information

Mazda Motor Corporation

3-1, Shinchi, Fuchu-cho, Aki-gun  
Hiroshima 730-8670, Japan  
TEL : 81(82)287-5323  
FAX : 81(82)287-5220



Category <b>BD</b>	<b>Repair Guidance</b>	Ref. No. R073/15	Page 1 of 14
Coverage <input type="checkbox"/> Distributor only <input checked="" type="checkbox"/> Please inform your dealers		Date Issued August 7, 2015	
Please convey this information to your <input type="checkbox"/> Director <input checked="" type="checkbox"/> General Manager <input checked="" type="checkbox"/> Warranty Dept. <input checked="" type="checkbox"/> Parts Dept. <input checked="" type="checkbox"/> Training Dept. <input checked="" type="checkbox"/> Field Rep.		Date Revised	
Applicable Model CX-5 (KE), Mazda6 (GJ), Mazda3 (BM): with SKYACTIV-D 2.2		Applicable Countries or Specifications Europe	

**NOTE: This Service Information supersedes R074/14.**

## Subject: Lack of acceleration “SKYACTIV-D 2.2” Prior Approval is required

### DESCRIPTION

Some vehicles may exhibit one or more of the following concerns with/without the following DTC(s) stored in PCM memory.

- Acceleration performance has become poor
- White smoke from exhaust system while driving
- MIL on with DTC P0299, P02CB and/or P2263

### PROCEDURE

When you encounter customer complaints on this concern, use the following diagnosis and repair procedure. **Note that prior approval is required.**

#### **Outline of diagnosis and repair procedure:**

1. Inspect the small and/ or large turbocharger for OK/NG condition.
  - If the small and/ or large turbocharger were found NG condition, proceed to step 2.
  - If both the small and large turbocharger were found OK condition, this Service Information is not applicable. Refer to Workshop Manual for diagnosis.
2. Perform engine flushing with flushing oil, replace engine oil filter with a modified one, and fill the engine with new engine oil.
3. Inspect the exhaust camshaft for OK/NG condition.
  - If the exhaust camshaft was found NG condition, proceed to step 4.
  - If the exhaust camshaft was found OK condition, this Service Information is not applicable. Refer to Workshop Manual for diagnosis.
4. Replace the following parts if judged NG by inspections:
  - 1) Turbocharger (If NG by inspection at STEP 1).
  - 2) Exhaust camshaft and rocker arms (If NG by inspection at STEP 3).

**IMPORTANT:** Replacement of turbocharger must be performed after engine flushing.

### STEP 1: Turbocharger inspection

Inspect the turbocharger for abnormal noise by raising the engine speed to 2,500 rpm.

**NOTE:** One person raises the engine speed and another person inspects for noise.

**NOTE:** Refer to the videos as examples of the turbocharger noise in attached file.

#### JUDGMENT:

If **ANY ABNORMAL NOISE** is heard at the engine speed of 2,500 rpm:

→ Go to **STEP 1A** and inspect the small turbocharger for damage on the blades.

If **NO ABNORMAL NOISE** is heard at the engine speed of 2,500 rpm:

→ The small turbocharger is **OK**. Go to **STEP 1B** and inspect the large turbocharger for damage on the housing/ blades.

#### STEP 1A: Inspection of small turbocharger blades for damage using a fiberscope

1. Remove the battery, fresh air duct, air cleaner element, air cleaner case and battery tray.
2. Remove the air outlet pipe component from the small turbocharger and set it aside.

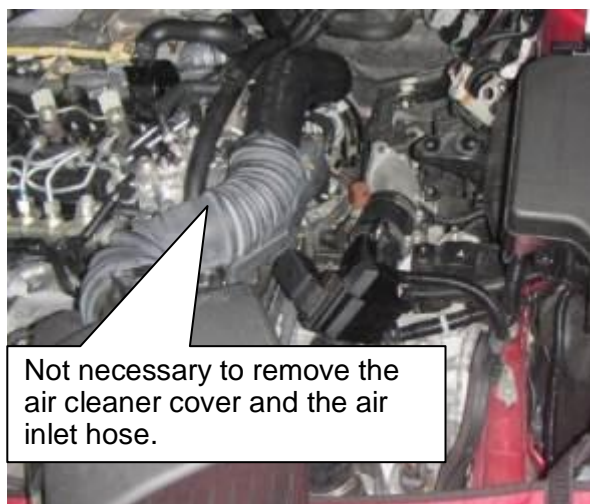



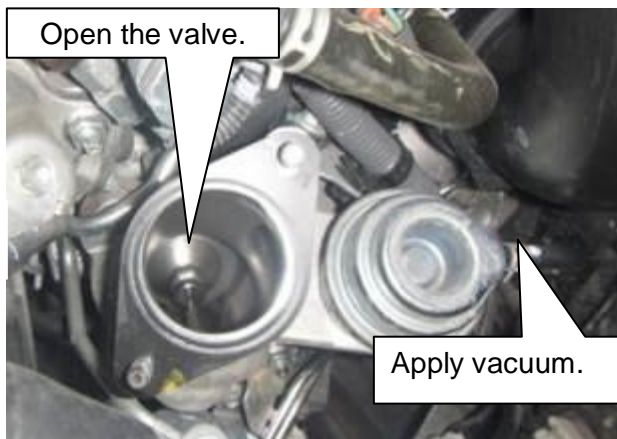
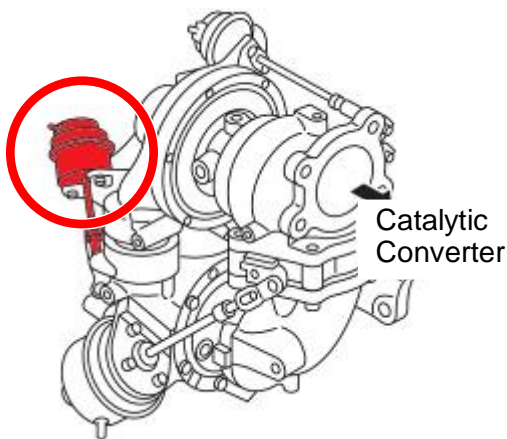

3. Connect a hand-operated vacuum pump (e.g. Mityvac) to the compressor bypass valve vacuum actuator and apply vacuum to open the valve.



4. Insert a fiberscope into the compressor bypass valve housing and inspect the small turbocharger blades for any damage on the outer edge.

**<Inspection Criteria>**

OK (No damage on blades)	NG (Damage on blades)	
No deformation on outer edge.	Saw-toothed deformation on outer edge	Entire outer edge deformed.
		
		

**JUDGMENT:**

If **NO DAMAGE** is found on the outer edge of any blades:

➔-The small turbocharger is **OK**. Go to **STEP 1B** and inspect the large turbocharger for damage on the housing/ blades.

If **ANY DAMAGE** is found on the outer edge of any blades:

➔-The small turbocharger is **NG** and the turbocharger assembly needs to be replaced. Go to **STEP 2**.



**STEP 1B: Inspection of large turbocharger for damage on the housing/ blades**

1. Remove the air inlet hose to large turbocharger.
2. Visually check the housing inside wall, in the area where the turbine blades are located, for scratch marks using an inspection mirror.
3. Inspect the large turbocharger blades for any damage on the outer edge.



Visual inspection on the inside wall of housing

<Inspection Criteria>

OK (No scratches or damage on blades)	NG (Scratches and/ or damage on blades)	
No scratches and no damage on blades.	Scratches causing the housing to appear whitish	Saw-toothed deformation on the outer edge of blades
		

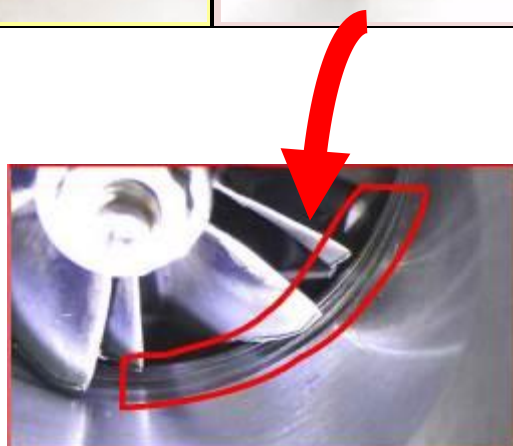

**JUDGMENT:**

If **NO DAMAGE** is found on the housing inside wall or the outer edge of any blades:

→The large turbocharger is **OK**.

If both the small and the large turbocharger are **OK**, this **Service Information** is not applicable. Refer to **Workshop Manual** for diagnosis.

If **ANY DAMAGE** is found on the housing inside wall and/ or the outer edge of any blades:

→The large turbocharger is **NG** and the turbocharger assembly needs to be replaced. Go to **STEP 2**.

## STEP 2: Flushing the engine with engine oil

**NOTE:** If engine oil leakage from and/or around turbocharger or intercooler was found, repair the oil leakage before performing engine flushing.

1. Install the parts removed from the turbocharger in the reverse order.

**NOTE:** To perform engine flushing temporarily install the air outlet pipe component with the old gasket, and install a new gasket when replacing the turbocharger. The gasket is included in Kit C.

2. Warm up the engine and, using M-MDS “ARPMDES” PID, keep the engine rpm at 2,000 rpm for 3 min.

3. Stop the engine, drain the original engine oil but do not discard the gasket. Reuse the removed gasket for the flushing procedure. Fill the engine with the flushing oil detailed in the parts information section.

4. Start the engine and, using M-MDS “ARPMDES” PID, keep the engine rpm at 2,000 rpm for 3 min.

5. Stop the engine and drain the flushing oil. Use a new gasket, replace the oil filter with a modified one (for details refer to SI E023/14A), and fill the engine with new engine oil.

6. Perform oil data reset.

7. Go to STEP 3.

## STEP 3: Exhaust Camshaft Inspection

1. Remove the cylinder head cover, and check the high lift cams of the exhaust camshaft for wear.

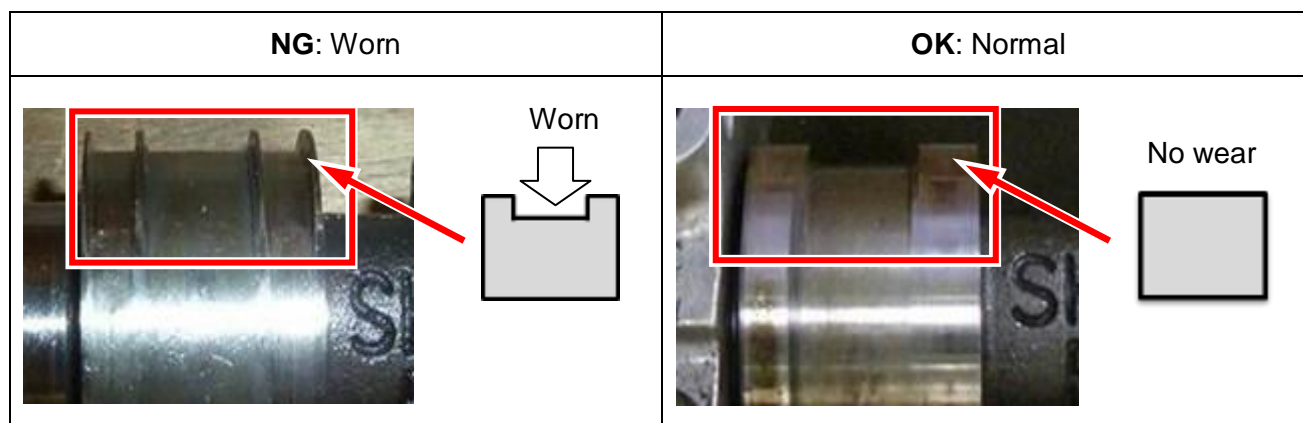

### JUDGMENT:

If the high lift cam on the exhaust camshaft is worn:

➔ **The exhaust camshaft is NG. Go to STEP 4.**

If no wear is found:

➔ **The exhaust camshaft is OK, i.e. this Service Information is not applicable. Refer to Workshop Manual for diagnosis.**

#### STEP 4: Parts replacement

1. According to the inspection result of previous STEPs replace the parts that were found NG condition. For selection of the required kits refer to the table below:

Inspection items		Judgment result		
		NG	OK	NG
	STEP 1A: Small turbocharger	NG	OK	NG
	STEP 1B: Large turbocharger	OK	NG	NG
	STEP 3: Exhaust camshaft	NG	NG	NG
		↓	↓	↓
Kits required	Kit A		X	
	Kit B		X	
	Kit C		X	

2. Only if the turbocharger has been replaced: Perform turbocharger initialization.

**NOTE:** When replacing exhaust camshaft and rocker arms, refer to SH Exhaust Camshaft Removal/ Installation procedure in the attachment on page 8.

End of repair procedure

#### PARTS INFORMATION

Part Number	Part Name	Q'ty	Remark
SHY3-10-YG0	Kit A	1	-
SHY2-10-YA0	Kit B	1	-
SHY1-13-70Z	Kit C	1	-
FLUS-05-OIL	FLUSHING OIL	1	Engine flushing (5 Liter)
SH01-14-302A	Oil filter	1	-
99564-1400	Gasket	1	-
5555-DE-001	Engine oil	5.1	Mazda Genuine Oil

BEGINNING VIN & DATE OF MODIFICATION

**Mazda3 (BM)**

Spec.	Beginning VIN		Date of Modification
EC	JMZ BM **** **	112007	September 17, 2013

**Mazda6:**

Spec.	Beginning VIN		Date of Modification
EC	JMZGJ**** **	148781	September 17, 2013
ADR	JM0GJ**** **	122521	September 17, 2013

**CX-5:**

Spec.	Beginning VIN		Date of Modification
EC	JMZKE**** **	248119	September 17, 2013
UK	JMZKE**** **	163230	September 17, 2013
ADR	JM0KE**** **	224059	September 17, 2013

For reference only:

The beginning engine no. of the modification is as following:

Mazda3 (BM) and Mazda6 (GJ): SH3-0352618

CX-5 (KE): SH3-0352072

Service part (replacement engine): From SH3-0352618

WARRANTY INFORMATION

Assembly group		B – Reciprocating Engine
		04 - CYLINDER HEAD
Symptom Code		36
Damage Code		9C
Causal Part No.		7777-SP-J62
Q'ty		0
Operation No. & Labor Hours	Turbocharger, Camshaft, rocker arms replacement & flushing *	<b>XXL5DXRX:</b> Mazda3: 8.2 Hrs CX-5 2WD: 8.4 Hrs CX-5 4WD: 9.6 Hrs Mazda6: 8.2 Hrs
Period Covered		Normal Warranty Period
Prior Approval necessary		YES

\*: In case of turbocharger replacement add the wheel alignment time (Operation No.: A0109XAX [for CX-5 and Mazda6]; A0109AAX [for Mazda3]: 1.1 Hrs using 4-wheel alignment tester).

Ryu Shimizugawa  
Manager, Technical Information Gr.  
Technical Service Dept.  
Mazda Motor Corporation

## Attachment: SH Exhaust Camshaft Removal/ Installation

The below Exhaust Camshaft Removal/ Installation procedure is somewhat different from the Hydraulic Lash Adjuster Removal/ Installation procedure described in the Workshop Manual, i.e. some steps listed under Hydraulic Lash Adjuster Removal/ Installation are unnecessary when removing only the exhaust camshaft (e.g. there is no need to remove supply pump, CMP sensor, rear camshaft cap, intake camshaft). However, all of the Workshop Manual references listed in the below procedure can be found in MESI under HYDRAULIC LASH ADJUSTER (HLA) REMOVAL/INSTALLATION [SKYACTIV-D 2.2].

**WARNING:** A hot engine can cause severe burns. Turn off the engine and wait until it is cool before servicing.

**CAUTION:** When rotating the camshaft using a wrench on the cast hexagon, the wrench may contact the rocker arm and damage the rocker arm. To prevent damage to the rocker arm when holding the camshaft on the cast hexagon, use a wrench on the rear side of the engine as shown in the figure to secure a clearance between the cam.

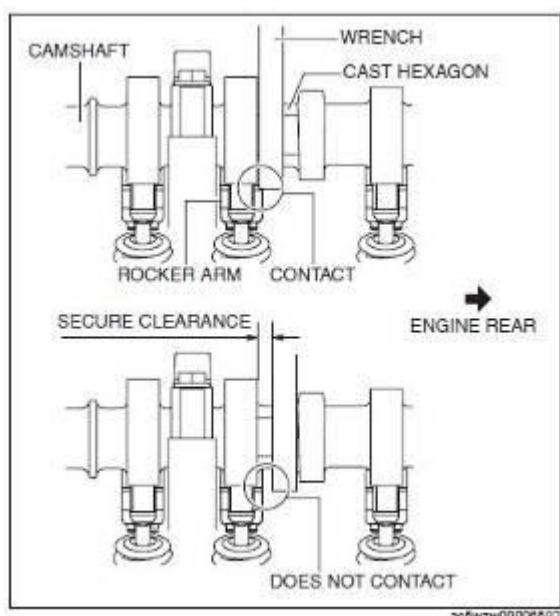

1. Disconnect the negative battery cable. (See NEGATIVE BATTERY CABLE DISCONNECTION/ CONNECTION [SKYACTIV-D 2.2].)
2. Remove the engine cover. (See ENGINE COVER REMOVAL/INSTALLATION [SKYACTIV-D 2.2].)
3. Remove the fuel injectors. (See FUEL INJECTOR REMOVAL/INSTALLATION [SKYACTIV-D 2.2].)
4. Remove the lower case. (See LOWER CASE REMOVAL/INSTALLATION [SKYACTIV-D 2.2].)
5. Remove the cylinder head cover. (See TIMING CHAIN REMOVAL/INSTALLATION [SKYACTIV-D 2.2].)
6. Remove the splash shield. (See SPLASH SHIELD REMOVAL/INSTALLATION.)
7. Remove the oil shower pipe.



8. Remove the noise suppression cover no.1 and the seal rubber (if equipped) (See HYDRAULIC LASH ADJUSTER (HLA) REMOVAL/INSTALLATION [SKYACTIV-D 2.2], Noise Suppression Cover (No.1), Seal Rubber Removal Note.)
9. Set the timing chain aside from the exhaust camshaft (See HYDRAULIC LASH ADJUSTER (HLA) REMOVAL/INSTALLATION [SKYACTIV-D 2.2], Timing Chain Removal Note.)

**NOTE:** For explanation purposes the timing chain cover is removed on some of the pictures shown in the Timing Chain Removal procedure. However, for exhaust camshaft removal it is not necessary to remove the timing chain cover.

10. Remove the exhaust camshaft (see Exhaust Camshaft Removal Note on page 11)
11. Replace the IDEVA rocker arms (See HYDRAULIC LASH ADJUSTER (HLA) REMOVAL/INSTALLATION [SKYACTIV-D 2.2], Rocker Arm Installation Note.)
12. Install the new exhaust camshaft (see Exhaust Camshaft Installation Note on page 13)
13. Install the remaining parts in the reverse order of removal.

**NOTE:** Make sure to follow the below service points during installation of timing chain and fuel injectors.

#### **Service Point 1: Exhaust camshaft sprocket installation**

When installing the exhaust camshaft sprocket, make sure to correctly align the sprocket groove with the camshaft locating pin. Otherwise the locating pin might be pushed in, causing damage to both sprocket and pin. This might result in misalignment between camshaft and crankshaft (DTC P1336 might get logged in the PCM) and in the worst case to engine damage.



Camshaft sprocket groove damaged



Camshaft locating pin pushed in

#### **Service Point 2: Exhaust camshaft sprocket fixing bolt tightening**

Thin head type torque wrench is recommended in SI MME/T001/14.

**– Too low tightening torque results in engine damage.**



### Service Point 3: Fuel injector bore cleaning

The cleaning procedure is announced by SI MME/E004/12, and the cleaning kit is introduced by SI MME/T005/12.

– Improper cleaning results in combustion gas leakage.

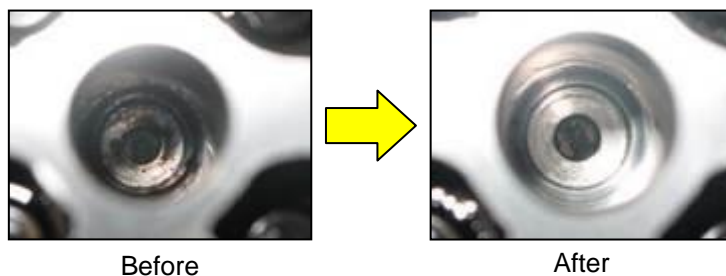

### Service Point 4: Fuel injector tightening

Follow the modified tightening procedure which is announced by SI E003/14.

- If the injector clamping force is too low, this will result in combustion gas leakage.
- If the injector clamping force is too high, the injector operation is impaired due to deformation of the nozzle body.



### Exhaust Camshaft Removal Note

1. Loosen the exhaust camshaft cap bolts in two or three passes in the order shown in the figure, and remove the exhaust camshaft caps.

**CAUTION:** Do not remove the camshaft cap at the engine rear side. If removed, the O-rings must be replaced with new ones, and adhesive sealant must be applied to the contact surface.

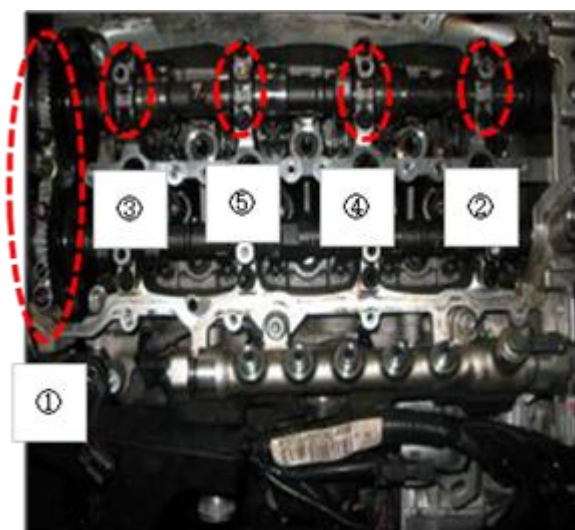

- Turn the exhaust camshaft until the groove driving the supply pump is in the position shown in below picture (piston no.1 in TDC position).



- Hold the exhaust camshaft on the front side (sprocket side) and slightly lift the front part of the camshaft.



- Turn the exhaust camshaft clockwise until the groove driving the supply pump is in the horizontal position.



- Pull the exhaust camshaft out from the supply pump connection and remove it from the cylinder head.



Make sure that the cam lobes do not touch the cylinder head journals during removal.

### Exhaust Camshaft Installation Note

1. Apply gear oil (SAE No. 90 or equivalent) or engine oil to the following locations.
  - Each journal of the cylinder head
  - Needle roller bearing and slipper area of the rocker arm



2. Apply gear oil (SAE 90 or equivalent) or engine oil to the following locations of each camshaft.
  - Gear sliding surfaces
  - Thrust surface of front journal

**NOTE:** If oil is applied to the front camshaft cap, oil should not be applied to the thrust surface of the front journal.

3. Position the supply pump connection as shown in below picture.



4. Hold the exhaust camshaft on the front side (sprocket side) and insert it into the supply pump connection.



5. Turn the exhaust camshaft clockwise until there is no more interference between cam lobes and cylinder head journals, and then place it on the cylinder head.



6. Align the alignment mark of the exhaust camshaft with that of the intake camshaft.

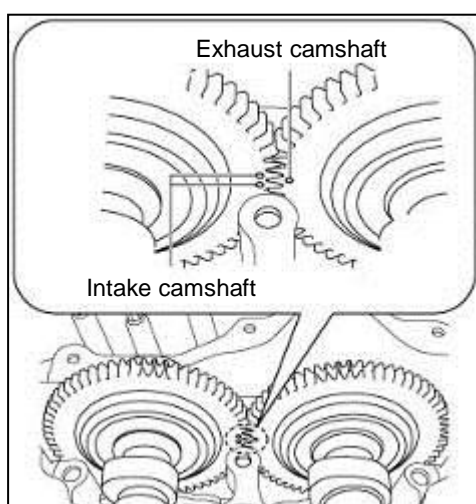

7. As shown in the figure, apply gear oil (SAE No. 90 or equivalent) or engine oil to the center area of each journal of the camshaft.



8. Apply gear oil (SAE 90 or equivalent) or engine oil to the thrust surface of the front camshaft cap.

**NOTE:** If oil is applied to the front journal thrust surface of each camshaft, oil should not be applied to the front camshaft cap.

9. Install the camshaft caps in the marked number order, and temporarily tighten the camshaft cap installation bolts in two or three passes evenly.
10. Tighten the camshaft cap installation bolts in two steps in the order shown in the figure.

